

# **Bargaining Dynamics and Varied Linking Costs in Stable Networks**

**Erik Darpö**

Linköping University

**Alvaro Domínguez**

Asian Growth Research Institute

**María Martín Rodríguez**

UIC Barcelona

Working Paper Series Vol. 2024-04

March 2024

The view expressed in this publication are those of the author(s) and do not necessarily reflect those of the Institute.

No part of this article may be used or reproduced in any manner whatsoever without written permission except in the case of brief quotations embodied in articles and reviews. For information, please write to the Institute.

**Asian Growth Research Institute**

# Bargaining Dynamics and Varied Linking Costs in Stable Networks\*

Erik Darpö<sup>1</sup>, Alvaro Domínguez<sup>2</sup>, and María Martín-Rodríguez<sup>3</sup>

<sup>1</sup>Linköping University.

<sup>2</sup>Asian Growth Research Institute.

<sup>3</sup>UIC Barcelona.

March 26, 2024

## Abstract

In a scenario featuring two distinct player types, we examine the pairwise stability of stationary networks where agents engage in infinite-horizon bargaining games akin to Manea’s framework. Link formation and maintenance costs are contingent upon communication ease and complementarities, with connections between individuals of different types becoming less expensive when complementarities are sufficiently strong. In such instances, various bipartite components emerge as stable, characterized by a lack of direct connections between players of the same type. These components exhibit inequitable distributions of surplus, resulting in asymmetric splits among linked individuals. This contrasts with scenarios where connections between individuals of the same type are less costly, leading to predominantly equitable stable components. Our findings highlight how complementarities and the relative scarcity of certain types can influence the fairness of bargaining outcomes within networks.

*Keywords:* Bargaining, Heterogeneity, Networks, Pairwise stability.

*JEL classification:* C72, C78, D85

## 1 Introduction

Collaborations among researchers to produce scientific outcomes are the norm nowadays in many disciplines. The average number of co-authors across all disciplines of study has grown from 9.47 in 2012 to 25.10 in 2016. In the physical sciences, the

---

\*We would like to thank Antonio Cabrales, Simona Fabrizi, Makoto Hanazono, Steffen Lippert, Angel Lopez, Daniel Marszalec and Nikolas Tsakas for useful comments and suggestions. Any remaining errors are solely our responsibility.

average number of authors has increased from 9.46 to 38.61 for the above period, surpassing a thousand authors in the most extreme cases. In the same spirit, between 1980 and 2016, 76% of the papers published in Economics have two or more authors.<sup>1</sup>

How researchers associate depends on their own skills and the characteristics of the projects, which are all assumed to be financed through research funds normalized to one monetary unit per project. Suppose that there are two types of players, say theorists and empiricists, and two mutually exclusive states of the world, say projects that require a single skill of either type or both skills simultaneously.<sup>2</sup> We aim to characterize the stable networks in this setting.

When deciding whether to create or break a link, players face a trade-off: on the one hand, the received share of the funding depends on their relative position in the network, which affects their bargaining power. On the other hand, players pay a cost for building and sustaining links with other researchers and for developing projects.

Although it is natural to assume that creating and maintaining a link between researchers with different skills is more expensive, the project development cost depends on the state of the world. In particular, if projects require a single type of skill, the development cost will be lower between two researchers with the same ability; however, it will be the opposite if projects require both types of skills.

The aggregate cost and the bargaining outcomes determine the structures of the stable components of the network. If in the overall it is cheaper to connect with a researcher with the same skill—which happens if projects require a single skill and *may* happen if they require both—we get the familiar result that only pairs, lines of three and odd cycles are stable.<sup>3</sup> If in the overall it is cheaper to connect with a researcher with a different skill—for which projects requiring both skills is a necessary condition—many other components also become stable, such as odd lines, stars (isolated or connected) and star-like trees.

All these new stable components are bipartite graphs<sup>4</sup> such that there are no links between two players of the same type.<sup>5</sup> This implies that, given the features of the bargaining game, all players of the same type in the component receive the same share and that it differs from  $1/2$ . Intuitively, these components are stable for certain cost ranges because, although two players getting the low share can improve their bargaining power by creating a link among themselves, this action is comparatively expensive.

There are several ways in which players can be “different.” Besides the interpretation based on skills, it is also possible to think in terms of the countries where the researchers are based, resulting in domestic or international collaborations. As an illustration, articles in science and engineering with at least one international

---

<sup>1</sup>Please refer to <https://www.natureindex.com/news-blog/paper-authorship-goes-hyper> for more details.

<sup>2</sup>We thank Angel Lopez for suggesting this interpretation.

<sup>3</sup>These results are the same as in the framework by [Gauer and Hellmann \(2017\)](#), where all links are equally costly to form.

<sup>4</sup>A bipartite graph is a graph that does not contain any odd-length cycle.

<sup>5</sup>Further regularity constraints are derived in Section 4.

co-author have grown from 16% in 1997 to 25% in 2012; in the same vein, domestic collaborations rose from 36% to 44% during the same period.<sup>6</sup> By field, international co-authorship has also increased: shares range from 56% for astronomy, 27-34% for mathematics, physics and biological sciences to 17-21% for chemistry and the social sciences.<sup>7</sup>

When talking about domestic or international collaborations, it also makes sense to consider that nature chooses the state of the world. For instance, authorities can call for projects that require researchers from different countries to collaborate to be eligible to receive funding. To illustrate, the European Union will allocate EUR 1.65 billion to the Marie Skłodowska-Curie Actions out of the EUR 50.5 billion of Horizon 2020, the EU Framework Program for Research and Innovation, which accounts for 3.27% of the total budget.<sup>8</sup> Further examples of funding for international collaborations include the Humboldt Research Fellowship for Postdoctoral Researchers in Germany and the JSPS Postdoctoral Fellowships for Research in Japan.

This paper contributes to the literature on stability of bargaining networks. The consideration of two types of players naturally results in cost heterogeneity. The novel result of additional bipartite graphs becoming stable in this setup widens our understanding of the conditions for these structures to appear. The importance of this result is double: *first*, it resembles some of the structures that research networks exhibit in real life<sup>9</sup> and *second*, as it determines the cost ranges for which these components are stable, it may help design policies oriented toward achieving networks with certain attributes.

Section 2 describes the model. Section 3 characterizes the stable components and networks when connections between players of the same type are cheaper. Section 4 performs the analogous exercise when connections between players of different types are cheaper, and Section 5 concludes. The mathematical proofs are presented in Appendix A.

## 1.1 Literature Review

Our paper contributes to the literature of bargaining in networks in which the linking costs are heterogeneous because players are of different types.

The literature of R&D networks has modeled the reduction in production costs via connections with other firms as a reason behind these collaborations. Ex-ante identical firms are also identical ex-post if the equilibrium network is symmetric, but heterogeneous ex-post if the equilibrium network is asymmetric. In contrast, our linking cost are heterogeneous by assumption and symmetric networks are stable in equilibrium for certain cost ranges. Moreover, in our setup the stability of a symmetric equilibrium network does not imply that players pay the same cost.

---

<sup>6</sup>In reality, these two figures expand simultaneously at the expense of single-authored papers.

<sup>7</sup>This information is available at <https://www.nsf.gov/statistics/seind14/index.cfm/chapter-5/c5s4.htm>

<sup>8</sup>2.37% is destined to fund collaborations among the EU members and the remaining 0.92% to fund collaborations with the rest of the world, including the UK.

<sup>9</sup>See for example Newman (2004).

Goyal and Moraga-Gonzalez (2001) study R&D networks in which the marginal cost decreases in the own effort of the firm and the effort of their neighbors. The cost of the own effort is increasing and exhibits decreasing returns. A link makes the two firms involved more competitive, which in turn affects the degree of competition in the market. The complete network is stable when firms compete in independent markets and in Cournot oligopolies. In our framework, the complete network is never stable: additional links may not change the bargaining power of the players involved, making its creation unprofitable.

Goyal and Joshi (2003) study R&D networks in which the marginal cost decreases linearly in the number of links. In Cournot oligopolies with non-negligible linking costs, firms have increasing returns from links, which implies that any stable network can have at most one non-singleton component and that this component must be complete.<sup>10</sup> Our framework also allows for more than one isolated node in equilibrium, but it is not always the case that there is one non-singleton component and that these components are complete. As before, the characteristics of the considered bargaining process are behind this difference.

Whereas the positive effect of creating a link in R&D networks happened through a cost reduction, in information networks it happens through the additional information owned by other players that now becomes accessible.

Galeotti et al. (2006) study strict Nash equilibria in networks in which one agent pays the linking cost but the information flows both ways. Information is acquired through direct and indirect connections, and the authors allow for value and cost heterogeneity.<sup>11</sup> With homogeneous values and a linking cost that increases in the distance between groups of players, all equilibria different from the empty network consist of center-sponsored stars.<sup>12</sup> By contrast, we find stars and related structures when it is cheaper to link with the different group. Their no decay assumption with regards the information acquisition and the fact that pairwise stability is a weaker equilibrium concept than strict Nash equilibrium explain this difference.

Galeotti and Goyal (2010) also study networks in which one agent pays the linking cost but the information flows both ways. Players decide whether to acquire the information personally or from others through direct and indirect connections. Since the returns from information are increasing and concave while the costs of acquiring information personally are linear, strict Nash equilibria exhibit the core-periphery architecture. No heterogeneity is necessary for this result, but introducing a slight cost advantage in personally acquiring information predicts a unique equilibrium in which the low cost player is the single hub of the star. The stability of the star in our setup with bargaining depends on the form of the heterogeneity: stars of  $n \geq 4$  are not stable when it is cheaper to connect with players of the same type.<sup>13</sup>

---

<sup>10</sup>To get equilibria such that they are unique with respect to the size of the dominant group given the linking cost, and the size of this group is monotonically decreasing in the linking cost, Dawid and Hellmann (2014) study the same framework but make it dynamic and look for stochastic stable networks: one existing or potential new link is randomly chosen every period to be reviewed by the two involved firms, who will make a mistake with a small probability.

<sup>11</sup>These heterogeneities extend the framework by Bala and Goyal (2000).

<sup>12</sup>Depending on the costs, the equilibrium is either a generalized star or several unconnected stars.

<sup>13</sup>Gauer and Hellmann (2017) also get this result in bargaining networks with homogeneous costs.

In bargaining networks, the positive effect of an additional link happens through a subtler channel than in information networks. Whereas in the latter it happens by simple aggregation, in the former an additional link may alter the relative bargaining power of the players involved.<sup>14</sup>

Manea (2011) studies an infinite-horizon bargaining game in a stationary, undirected network.<sup>15</sup> Stationarity is modeled as follows: players reaching an agreement leave the market but are replaced by identical players in the subsequent period that assume the same positions in the network, and so the network structure remains the same. Taking the network structure as given, the author shows that not all existing links will be used when players are patient enough; that is, there are pairs of players that, when selected to bargain, do not reach an agreement and instead prefer to wait to be matched with another trading partner.

These disagreement links motivates the approach by Gauer and Hellmann (2017). We also build a model of two stages in which the strategic network formation happens in the first stage and a stationary bargaining game *à la Manea* takes place in the second stage. The main difference is that they consider homogeneous linking costs while we introduce heterogeneity. Our results are qualitatively similar when connections between players of the same type are cheaper: stable non-singleton components are pairs, lines of three and odd cycles. However, when connections between players of different types are cheaper, many other bipartite graphs such that there are no links between players of the same type also become stable.

Other authors have focused on bargaining in non-stationary networks. Non-stationarity means that the players who reach an agreement leave the game without being replaced in the subsequent period. Kranton and Minehart (2001), Corominas-Bosch (2004) and Elliott and Nava (2019) restrict their attention to bipartite graphs by studying relationships between buyers and sellers or employers and employees. On the contrary, our bipartite graphs are equilibrium results. Abreu and Manea (2012a,b) consider a general setting in which some agents may act as both buyers and sellers for other agents in the networks. Analogously, we also obtain pairwise stable structures that are not bipartite graphs. Finally, Polanski (2007) and Bloch et al. (2019) also analyze general architectures but the equilibrium payoffs are determined by the classification of nodes in the the Gallai–Edmonds decomposition.

## 2 The model

We consider a two-stage game. In the first stage,  $t = 0$ , players form undirected, costly links. The cost of each link is determined by (i) the types of the connecting players, and (ii) the state of the world. Both the players' types and the state of the world are exogenously determined and common knowledge. In the second stage,  $t = 1, 2, \dots$ , given the network formed previously, an infinite-horizon game in which pairs of players connected by a single link are randomly matched to bargain *à la Manea* takes place.

---

<sup>14</sup>Seminal contributions to the bargaining literature are Nash (1950, 1953) and Rubinstein (1982).

<sup>15</sup>Rubinstein and Wolinsky (1985) analyze the first model of decentralized bargaining in stationary markets.

### □ Networks

Let  $N = \{1, 2, \dots, n\}$ ,  $n \geq 3$  be the set of players. There are two types of players,  $E$  and  $T$ . We consider  $N_E = \{1, 2, \dots, n_E\}$  and  $N_T = \{1, 2, \dots, n_T\}$  such that  $n_E + n_T = n$ .

Denote a *link* between players  $i, j \in N$ ,  $i \neq j$ , by  $ij = ji := \{i, j\}$ . The complete network,  $g^N$ , is defined as the network in which every pair of distinct players are connected to each other by a single link.<sup>16</sup> Then, the set of all undirected networks is  $G = \{g \mid g \subseteq g^N\}$ . We represent the *neighbors* of player  $i$  in the network  $g$  by the set  $N_i(g) = \{j \in N \mid ij \in g\}$  and refer to  $\eta_i(g) = |N_i(g)|$  as its cardinality or, equivalently, as the *degree* of player  $i$ . A player is *isolated* if they have no neighbors.

Given a network  $g$ , a *path* between  $i$  and  $j$  is a sequence of players  $i_1, i_2, \dots, i_M$  such that  $i_m i_{m+1} \in g$  for all  $m \in \{1, \dots, M-1\}$ , with  $i_1 = i$  and  $i_M = j$ . The set  $C \subseteq N$  is a *component* of network  $g$  if there exists a path between any two players in  $C$  and it is  $N_j(g) \cap C = \emptyset$  for all  $j \notin C$ . A *subnetwork*  $g' \subseteq g$  is *component-induced* if there is a component  $C$  of  $g$  such that  $g' = g|_C$ , where the network  $g|_K := \{ij \in g \mid i, j \in K\}$  is the subnetwork restricted to the players  $K \subset N$ .

Finally, let  $g + ij := g \cup \{ij\}$  denote the network obtained by adding link  $ij$  to the existing network  $g$ , and  $g - ij := g \setminus \{ij\}$  denote the network obtained by deleting link  $ij$  from the existing network  $g$ .

### □ Costs

In order to generate the unit of surplus for which they will bargain later on, players need to incur a cost composed of two factors: the cost of forming and sustaining a collaboration link, and the cost of running a project. These components depend on the players' types,  $E$  and  $T$ , and the state of the world,  $S$  and  $B$ , which are assumed to be mutually exclusive. Both the types and the state of the world are exogenously determined and common knowledge.

The cost of forming and sustaining a *link* depends on the players' types. For the sake of exposition, consider that  $E$  and  $T$  stand for empiricists and theorists. It is cheaper to link with an agent of the same type: communication is easier because of the similar background. Then, we can write  $c^{\ell, a} < c^{\ell, d}$ , where  $c^{\ell, a} := c^{\ell, EE} = c^{\ell, TT}$  and  $c^{\ell, d} := c^{\ell, ET} = c^{\ell, TE}$ .

The cost of running a *project* depends on both the players' types and the state of the world. Consider that  $S$  means that projects require a single skill whereas  $B$  signifies that projects require both skills. If the state of the world is  $S$ , then  $c^{\mathcal{P}, a} < c^{\mathcal{P}, d}$  holds, where  $c^{\mathcal{P}, a} := c^{\mathcal{P}, EE} = c^{\mathcal{P}, TT}$  and  $c^{\mathcal{P}, d} := c^{\mathcal{P}, ET} = c^{\mathcal{P}, TE}$ . However, if the state of the world is  $B$ , the developing costs relate in the opposite way:  $c^{\mathcal{P}, a} > c^{\mathcal{P}, d}$ .

The underlying idea behind these inequalities is that, to complete a project in the state of the world  $S$ , a pair of players with different skills need to pay an extra cost because one of them needs to instruct the other in the skill they don't have. On the contrary, to complete the project in the state of the world  $B$ , two players with the same skill need to pay an extra cost to acquire the knowledge mastered by

<sup>16</sup>Formally, the complete network is the set of all subsets of  $N$  of size 2.



the other type.<sup>17</sup>

Denote the lowest overall cost by  $\underline{c}$  and the highest overall cost by  $\bar{c} > \underline{c}$ . If projects require a single skill, links between players of the same type are cheaper in the overall:  $\underline{c} = c^a := c^{\ell,a} + c^{\mathcal{P},a}$  and  $\bar{c} = c^d := c^{\ell,d} + c^{\mathcal{P},d}$ . However, if projects require both skills, links between players of different types are cheaper in the overall (that is,  $\underline{c} = c^d$ ) if and only if  $c^{\ell,d} - c^{\ell,a} < c^{\mathcal{P},a} - c^{\mathcal{P},d}$ ; in other words, if and only if complementarities are strong enough to make the difference in the cost of running the project more than offset the difference in the cost of linkage.

### □ Bargaining

Given a network  $g$ , the bargaining stage *à la Manea* is as follows.<sup>18</sup> Each period  $t = 1, 2, \dots$  a link  $ij \in g$  is selected according to a uniform matching technology, which is a probability distribution over  $g$ 's links such that each link is chosen with equal probability. The chosen link generates one unit of surplus that the two involved players can divide among themselves.<sup>19</sup> Then, with probability  $1/2$ , one of the two players is chosen as the proposer to make an offer to the other player, the responder.

The offer specifies how to split the unitary surplus. If the responder rejects the offer, then both players receive a payoff of zero and stay in the game for the next period. If the responder accepts the offer, then both players exit the game with the shares agreed upon and in the next period two players identical to the ones who left replace them such that the network structure remains the same. The network structure, and all offers and responses are common knowledge.

The stationary equilibrium payoffs  $v^*$  correspond to the unique fixed point of the contraction that expresses the expected payoff of each player as the weighted sum of (a) their own continuation payoff, obtained whenever being the responder,<sup>20</sup> and (b) the maximum between the share agreed upon when being the proposer, obtained when the other player accepts the offer, and their own continuation payoff, obtained when the other player rejects the offer. The weights are the probabilities of being involved in the bargaining as the responder and as the proposer, given the network structure. For each player, the equilibrium payoff is found to depend only on their position in the network and the discount factor  $\delta$ .

We assume players that tend to be infinitely patient; that is,  $\delta \rightarrow 1$ . In this case, the limit equilibrium payoffs depend solely on the network structure and can be computed using a simple algorithm. To implement it, we define two sets:  $M$  and  $L^g(M)$ . For any set of players  $M \subseteq N$  and any network  $g$ , let  $L^g(M) := \{j \in N | ij \in g, i \in M\}$  be the corresponding partner set in  $g$ ; that is, the set of players who have  $g$ -links to players in  $M$ . Moreover, a set  $M \subseteq N$  is  *$g$ -independent* if there is no  $g$ -link between two players in  $M$ ,  $M \cap L^g(M) = \emptyset$ .

**Definition 1** (Manea, 2011). *For a given network  $g$  and player set  $N$ , the algorithm*

<sup>17</sup>We assume that this extra cost affects both players evenly.

<sup>18</sup>See Manea (2011) for a detailed explanation.

<sup>19</sup>Continuing with the interpretation of the research networks, the selected link means that the researchers are selected to run a project and the unit of surplus would be the research fund, which is normalized to 1.

<sup>20</sup>When being the responder, the player always gets their own continuation payoff: this is what they get when they reject the offer and so the proposer will never offer more than this value.



$\mathcal{A}(g)$  provides a sequence  $(r_s, x_s, M_s, L_s, N_s, g_s)_{s=1,2,\dots,\bar{s}}$  which is defined recursively as follows. Let  $N_1 := N$  and  $g_1 := g$ . For  $s \geq 1$ , if  $N_s = \emptyset$  then stop and set  $\bar{s} = s$ . Otherwise let

$$r_s := \min_{M \subseteq N, M \in \mathcal{I}(g)} \frac{|L^{g_s}(M)|}{|M|}, \quad (1)$$

where  $\mathcal{I}(g)$  denotes the set of nonempty  $g$ -independent subsets of  $N$ .

If  $r_s \geq 1$  then stop and set  $\bar{s} = s$ . Otherwise, set  $x_s = r_s/(1+r_s)$ . Let  $M_s$  be the union of all minimizers  $M$  in (1). Denote  $L_s := L^{g_s}(M_s)$ . Let  $N_{s+1} := N_s \setminus (M_s \cup L_s)$  and  $g_{s+1} := g|_{N_{s+1}}$  be the subnetwork of  $g$  induced by the players in  $N_{s+1}$ .

Let the result of  $\mathcal{A}(g)$  be given by the sequence  $(r_s, x_s, M_s, L_s, N_s, g_s)_{s=1,2,\dots,\bar{s}}$ . The limit equilibrium payoffs are then given by

$$\begin{aligned} v_i^* &= x_s & \forall i \in M_s, \forall s < \bar{s}, \\ v_j^* &= 1 - x_s & \forall j \in L_s, \forall s < \bar{s}, \\ v_k^* &= 1/2 & \forall k \in N_{\bar{s}}. \end{aligned}$$

At each step  $s$ , the algorithm  $\mathcal{A}(g)$  determines the largest mutually estranged set minimizing the *shortage ratio* in the subnetwork induced by the remaining players  $N_s$ ,  $g_s := g|_{N_s}$ . As  $M_s$  is  $g_s$ -independent, these players can only bargain with those in the partner set  $L_s$ . If the partner set is small compared to  $M_s$ , then players in  $L_s$  are in a powerful bargaining position, which allows them to get larger shares of the unitary surplus. By minimizing the shortage ratio, the algorithm identifies the players in strongest and weakest bargaining positions, since they will not find agreements with other players in equilibrium.

The limit equilibrium payoff for the players in the mutually estranged set  $M_s$  is  $x_s = r_s/(1+r_s) = |L_s|/|L_s + M_s| < 1/2$ , whereas their partners in  $L_s$  obtain  $1 - x_s = |M_s|/|L_s + M_s| > 1/2$ .<sup>21</sup> These players with extremal limit payoffs are removed and the algorithm continues to the next step. It stops when there are no more players left or when the minimal shortage ratio is larger than one, in which case all remaining players receive  $1/2$ .

#### □ Stability

When forming the network, the players anticipate the outcome of the bargaining stage  $v^*$ . The linking decisions reflect the following trade-off: on the one hand, creating a link to run a project may benefit the bargaining power of the players involved by altering their relative positions in the network; on the other hand, there is a cost for creating links and developing projects. As it was explained before, this aggregate cost depends on the players' types and the state of the world.

At  $t = 0$ , each player tries to maximize their profit, expressed as

$$u_i^*(g) := v_i^*(g) - \bar{\eta}_i(g)\bar{c} - \underline{\eta}_i(g)\underline{c}, \quad (2)$$

where  $\bar{\eta}_i(g)$  represents the number of  $i$ 's neighbors that it was expensive to link with, and  $\underline{\eta}_i(g)$  denotes the number of  $i$ 's neighbors that it was cheap to link with.

<sup>21</sup>Notice that  $x_s$  is increasing in the shortage ratio.

The profit profile  $u^* = (u_i^*)_{i \in N}$  is *component-decomposable* because  $u_i^*(g) = u_i^*(g|_{C_i(g)}) \forall i \in N$  and  $g$ , where  $C_i \subseteq N$  represents the component of player  $i$  in network  $g$ .<sup>22</sup> The algorithm  $\mathcal{A}(g)$  assigns isolated players the payoff 0.<sup>23</sup>

We use the equilibrium notion of Pairwise Stability and do not explicitly model the network formation in stage  $t = 0$ :

**Definition 2** (Jackson and Wolinsky, 1996). *A network  $g$  is pairwise stable if:*

1. for all  $ij \in g$  :  $u_i(g) \geq u_i(g - ij)$  and  $u_j(g) \geq u_j(g - ij)$ , and
2. for all  $ij \notin g$  : if  $u_i(g + ij) > u_i(g)$ , then  $u_j(g + ij) < u_j(g)$

The implicit assumption of network formation behind this stability concept is that any player can unilaterally delete a given link, but both players need to agree to build a link. An existing link is sustained if none of the two players involved is strictly worse off by doing so, and an existing link is deleted if at least one of the two players involved is strictly better off by doing so. Therefore, the networks that allow neither (mutually) profitable link formation nor profitable link deletion are pairwise stable.

### 3 Pairwise Stable Networks

Pairwise stable networks are composed of pairwise stable components that have no incentives to create links among themselves. From Manea (2011), a link  $ij \in g$  can only lead to an agreement if  $v_i^{*\delta}(g) + v_j^{*\delta}(g) \leq 1$  holds for  $\delta$  large enough. Otherwise, it is a *disagreement link*: irrelevant for the bargaining power of the agents (and so for the bargaining outcome) while costly to form and sustain. Intuitively, these links should not form. Let  $g^*$  be the *limit equilibrium network* of  $g$ , defined as the network obtained by deleting all disagreement links from  $g$  for  $\delta \rightarrow 1$ .

**Proposition 1** (Gauer and Hellmann, 2017). *If  $g$  is pairwise stable, then  $g = g^*$  and, hence,  $v_i^*(g) + v_j^*(g) = 1 \forall ij \in g$ .*

We reproduce below the *necessary conditions* for a network to be pairwise stable derived by Gauer and Hellmann (2017), which are independent of the cost structure.

By Proposition 1, if players receive the same payoff in a component  $C$ , then any pair of players  $i, j \in C$  such that  $ij \in g$  must get  $v_i^*(g) = v_j^*(g) = 1/2$ . Define  $\tilde{N}(g) := \{i \in N | v_i^*(g) = 1/2\}$ .

**Theorem 1** (Gauer and Hellmann, 2017). *If a network  $g$  is pairwise stable, then for any component  $C$  of  $g$  it holds that  $C \cap \tilde{N}(g) \in \{\emptyset, C\}$ . If  $C \cap \tilde{N}(g) = C$ , then it must be a separated pair or an odd cycle.<sup>24,25</sup>*

<sup>22</sup>See Gauer and Hellmann (2017) for further details on this point.

<sup>23</sup>Continuing with our interpretation in terms of research networks, this means that single authors cannot access any research funding because running a project individually is unaffordable.

<sup>24</sup>A separated pair denotes a subnetwork induced by a two-player component.

<sup>25</sup>A cycle with  $m$  players is induced by a component with cardinality  $m \geq 3$  such that all players have exactly two links. It is called odd if its cardinality is an odd number.

**Corollary 1** (Gauer and Hellmann, 2017). *If a network  $g$  is pairwise stable, then for any non-equitable component  $C$  of  $g$  there exists a unique partition  $M \dot{\cup} L = C$  with  $|M| > |L|$  and  $g|_M = g|_L = \emptyset$  such that payoffs are given by  $v_i^*(g) = x \forall i \in M$  and  $v_j^*(g) = 1 - x \forall j \in L$ , where  $x = |L|/(|M| + |L|)$ .*

In words, if a pairwise stable network contains a non-equitable component, then it must be bipartite: by Proposition 1, the payoffs of the connected players must add up to 1, what implies that players receiving the same payoff within a non-equitable component cannot be linked.

### 3.1 Cheap Links Between Players of the Same Type

In this subsection, we present the *sufficient conditions* for a network to be pairwise stable when links between players of the same type are cheaper in the overall.

Recall from the previous section that this is the case when (a) the state of the world is  $S$ ; that is, when projects require a single skill of either type to be developed, or (b) the state of the world is  $B$  if and only if  $c^{\ell,d} - c^{\ell,a} > c^{\mathcal{P},a} - c^{\mathcal{P},d}$ ; that is, when projects require both skills to be developed but the complementarities are not strong enough to make the difference in the cost of running the project more than offset the difference in the cost of linkage.

We say that a component is *homogeneous* if all players in it are of the same type, and *heterogeneous* otherwise.

The two lemmas deal with the stability of individual components, whereas the three theorems characterize pairwise-stable networks with more than one component.

#### 3.1.1 Components

**Lemma 1.** *Sufficient conditions for components to be pairwise stable:*

(i) *The homogeneous pair is pairwise stable if  $\underline{c} \leq \frac{1}{2}$ .*

*The heterogeneous pair is pairwise stable if  $\bar{c} \leq \frac{1}{2}$ .*

(ii) *The homogeneous line of length three is pairwise stable if  $\underline{c} = \frac{1}{6}$ .*

*The heterogeneous line of length three such that two nodes of the same type are consecutive is pairwise stable if  $\bar{c} = \frac{1}{6}$ .*

(iii) *The homogeneous odd cycle with at most  $\frac{1}{2\underline{c}}$  players is pairwise stable if  $\underline{c} \leq \frac{1}{6}$ .*

*The heterogeneous odd cycle with at most  $\frac{1}{2\bar{c}}$  players is pairwise stable if  $\bar{c} \leq \frac{1}{6}$ .*

*Proof.*

In the Appendix. □

**Lemma 2.** *The following components are not pairwise stable:*

(i) *Heterogeneous lines of length three such that two nodes of the same type are not consecutive.*

(ii) *Lines of length four or above.*

(iii) *Even cycles.*

*Proof.*

In the Appendix. □

These results include those in [Gauer and Hellmann \(2017\)](#) as particular cases. There are two results worth a comment: the heterogeneous lines of length three, and the heterogeneous odd cycles.

Notice that, for heterogeneous lines of length three to be pairwise stable, it must be that the two nodes of the same type are consecutive. The intuition for this result is as follows: if the two nodes of the same type are not consecutive, the two existing links are expensive, which requires  $\bar{c} \leq 1/6$ . However, being of the same type, for the two peripheral nodes it is profitable to connect themselves if  $\underline{c} \leq 1/6$ , which is automatically implied by the previous condition; that is, in a line of length three, it is not possible to sustain two expensive links while preventing a cheap one.

On the other hand, when the two nodes of the same type are consecutive in the line of length three, there are a cheap link and an expensive link. Since the two peripheral nodes are different, the structure is stable if  $\bar{c} = 1/6$ , because that is the limiting value to simultaneously sustain the existing expensive link and prevent the formation of the cycle by adding an expensive link. Also, since the expensive link is maintained, so is the cheap existing one.

With respect to the heterogeneous odd cycles, the pairwise-stability condition is the same regardless of the number of nodes of each type and their positions in the cycle: since the cycle is odd, it is not profitable to add any link and so the only concern is to sustain the existing ones. In this structure, any pair of players involved in a link break would see themselves at the extremes of an odd line, and this symmetry explains why sustaining one expensive link in the cycle is not less demanding than sustaining more than one expensive link.

### 3.1.2 Networks

**Theorem 2** (Pairwise stability of the empty network).

*The empty network is pairwise stable if  $\underline{c} \geq \frac{1}{2}$ .*

*Proof.*

In the Appendix. □

This result coincides with [Gauer and Hellmann \(2017\)](#): whereas in our setup the empty network may include nodes of different types, preventing the formation of a cheap link automatically prevents the formation of an expensive link, and so the relevant cost is  $\underline{c}$  only.

**Theorem 3** (Pairwise stable networks including only pairs and isolated nodes).

(i) *Networks consisting of the union of one isolated node and homogeneous pairs such that at least one is of the same type as the isolated, are pairwise stable if  $\frac{1}{6} < \underline{c} \leq \frac{1}{2}$ .*

- (ii) Networks consisting of the union of one isolated player and homogeneous pairs such that all are of the same type and different from the isolated, are pairwise stable if  $\underline{c} \leq \frac{1}{2}$  and  $\bar{c} > \max\{\frac{1}{6}, \underline{c}\}$ .
- (iii) Networks consisting of the union of homogeneous pairs, regardless of their types, and two isolated nodes such that each one of them is of a different type are pairwise stable if  $\frac{1}{6} < \underline{c} \leq \frac{1}{2} \leq \bar{c}$ . Additionally, if  $\underline{c} = \frac{1}{2}$ , then there can exist two isolated nodes of the same type or three or more isolated nodes of any type.
- (iv) Networks consisting of the union of pairs such that at least one is heterogeneous and one isolated node are pairwise stable if  $\frac{1}{6} < \underline{c} < \bar{c} \leq \frac{1}{2}$ . Additionally, if  $\frac{1}{6} < \underline{c} < \bar{c} = \frac{1}{2}$ , then there can exist two isolated nodes such that each one of them is of a different type.

*Proof.*

In the Appendix. □

Figure 1 depicts some of the equilibrium networks derived in Theorem 3.

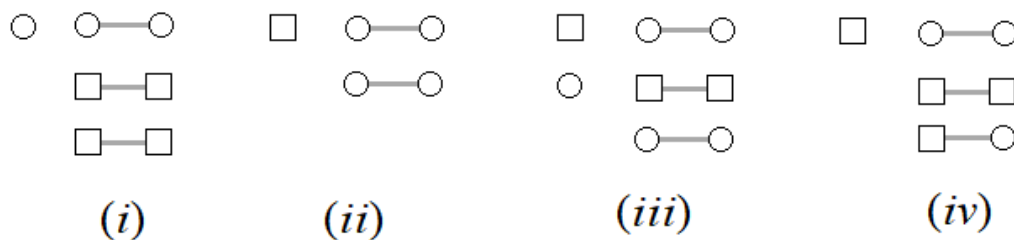

Figure 1: Stable networks with only pairs and isolated nodes.

The first statement of Theorem 3 contains the result in Gauer and Hellmann (2017) as a particular case, while it also allows for the existence of homogeneous pairs different from the isolated player. However, in the second statement all pairs are homogeneous and different from the isolated node, which is reflected in the stability condition: to prevent the link between an isolated node and a pair of the same type,  $1/6 < \underline{c}$  is sufficient, whereas to prevent the link between an isolated node and a pair of different type, the sufficient condition becomes  $1/6 < \bar{c}$ .

An important difference with Gauer and Hellmann (2017) is that there can be two isolated nodes rather than one in a network with only homogeneous pairs for different values of the costs within certain intervals. Of course, this happens because the condition to sustain the homogeneous pairs depends on  $\underline{c}$  and the condition to prevent the link between the two isolated nodes that are of different types depends on  $\bar{c}$ . However, to allow for the existence of two or more isolated nodes of the same type, we need to fix the cheap cost at the particular limiting value  $1/2$ .

Finally, it is also possible to sustain heterogeneous pairs with one isolated node for different values of the costs within certain intervals. Nonetheless, in order to allow

for two isolated nodes of different types to exist in this structure, the expensive cost needs to take the particular limiting value  $1/2$ . Notice that it is impossible to allow for three or more isolated nodes while sustaining heterogeneous pairs, because in that case it would be impossible to prevent the link between two isolated nodes of the same type.

**Theorem 4** (Pairwise stable networks that include cycles).

- (i) *Networks consisting of the union of homogeneous odd cycles, regardless of their types, with at most  $\frac{1}{2\underline{c}}$  players, and two isolated nodes, one of each type, are pairwise stable if  $\underline{c} \leq \frac{1}{6}$  and  $\bar{c} \geq \frac{1}{2}$ .*
- (ii) *Networks consisting of the union of homogeneous cycles, regardless of their types, with at most  $\frac{1}{2\underline{c}}$  players, and either homogeneous pairs, regardless of their types, or at most one isolated player are pairwise stable if  $\underline{c} \leq \frac{1}{6}$ . Additionally, if  $\underline{c} = \frac{1}{6}$  and given that there is no isolated player, then there can also be homogeneous lines of length three, regardless of their types.*
- (iii) *Networks consisting of the union of homogeneous cycles, regardless of their types, with at most  $\frac{1}{2\underline{c}}$  players, and pairs such that at least one of them is heterogeneous are pairwise stable if  $\underline{c} \leq \frac{1}{6}$  and  $\bar{c} \leq \frac{1}{2}$ . Additionally, if  $\underline{c} = \frac{1}{6}$ , then there can also be homogeneous lines of length three, regardless of their types.*
- (iv) *Networks consisting of the union of homogeneous odd cycles, regardless of their types, with at most  $\frac{1}{2\underline{c}}$  players, one isolated player and homogeneous pairs such that all are of the same type and different from the isolated node are pairwise stable if  $\underline{c} \leq \frac{1}{6} < \bar{c}$ . Additionally, if  $\underline{c} = \frac{1}{6}$ , then there can also be homogeneous lines of length three such that all are of the same type and different from the isolated node.*
- (v) *Networks consisting of the union of odd cycles such that at least one is heterogeneous, with at most  $\frac{1}{2\underline{c}}$  players in the homogeneous cycle(s) and at most  $\frac{1}{2\bar{c}}$  players in the heterogeneous cycle(s), and either pairs or at most one isolated player are pairwise stable if  $\bar{c} \leq \frac{1}{6}$ .*
- (vi) *Networks consisting of the union of odd cycles, with at most  $\frac{1}{2\underline{c}}$  players in the homogeneous cycle(s) and 3 players in the heterogeneous cycle(s), and one heterogeneous line of length three are pairwise stable if  $\bar{c} = \frac{1}{6}$ . Additionally, if  $\frac{1}{15} < \underline{c}$ , then there can also be pairs.*

*Proof.*

In the Appendix. □

Figure 2 depicts some of the equilibrium networks derived in Theorem 4.

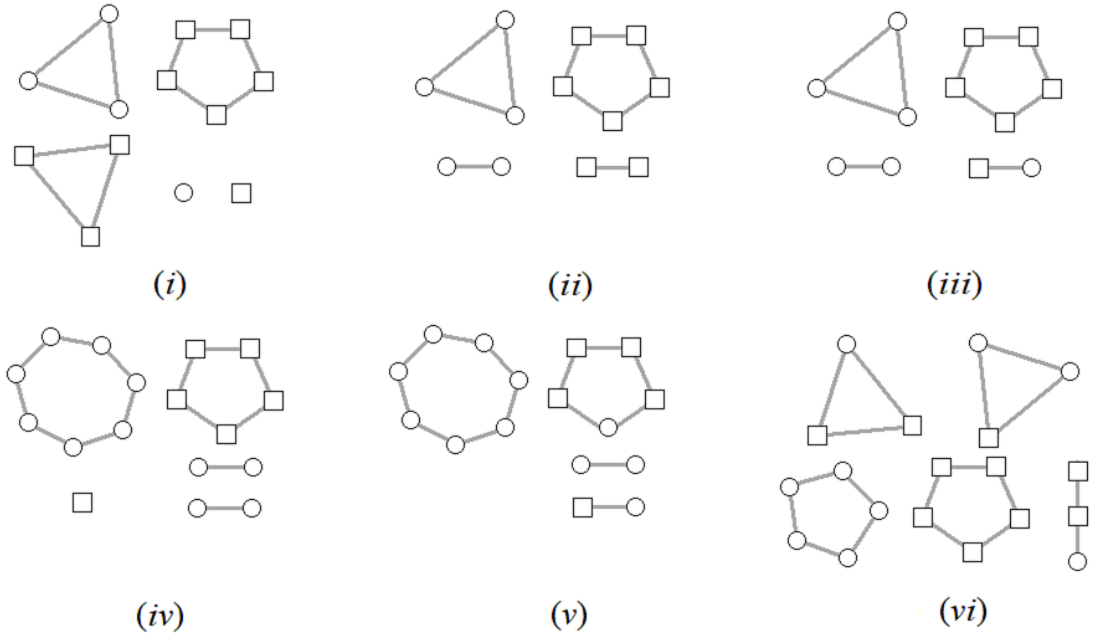

Figure 2: Stable networks including odd cycles.

Notice that the first statement of Theorem 4 cannot be obtained in [Gauer and Hellmann \(2017\)](#), because if a homogeneous odd cycle is sustainable, then the two isolated nodes of the same type will form a pair. However, if the isolated nodes are of different types, the sufficient condition to sustain the homogeneous odd cycle depends on  $\underline{c}$  whereas the sufficient condition to prevent the formation of a heterogeneous pair depends on  $\bar{c}$ .

The second statement of Theorem 4 includes the results in [Gauer and Hellmann \(2017\)](#) as a particular case, while it is not restricted to structures in which all pairs and cycles are of the same type (just being homogeneous is enough).

The lines of length three deserve further attention, as their existence in the pairwise stable network structures limits the characteristics of the other components. In particular, homogeneous lines can co-exist with isolated nodes of different type, pairs, other homogeneous lines and homogeneous cycles with three players, but not with heterogeneous cycles. On the other hand, heterogeneous lines cannot co-exist with other lines or isolated players, but they can with pairs and cycles. Moreover, they limit the number of players in the heterogeneous cycles to three, but they do not limit the number of players in the homogeneous cycles.

Finally, it is important to remark that there are multiple equilibria for certain parametric conditions. For example, if  $\underline{c} \leq 1/6 \wedge 1/6 < \bar{c} \leq 1/2$ , a network structure with the characteristics defined in Theorem 2 (ii) is pairwise stable, and so is a network structure with the characteristics defined in Theorem 3 (iii). Our results simply state that the two configurations are pairwise stable, but nothing is said about which configuration would be finally reached, or with which probability.



## 3.2 Cheap Links Between Players of Different Types

In this subsection, we present the *sufficient conditions* for a network to be pairwise stable when links between players of different types are cheaper in the overall.

Recall from the previous section that this is the case when the state of the world is  $B$  if and only if  $c^{\ell,d} - c^{\ell,a} < c^{\mathcal{P},a} - c^{\mathcal{P},d}$ ; that is, when projects require both skills to be developed and the complementarities are strong enough to make the difference in the cost of running the project more than offset the difference in the cost of linkage.

As before, a component is *homogeneous* if all players in it are of the same type and *heterogeneous* otherwise.

The lemma below deals with the stability of individual components.

### 3.2.1 Components

**Lemma 3.** *Sufficient conditions for components to be pairwise stable:*

- (i) *The homogeneous pair is pairwise stable if  $\bar{c} \leq \frac{1}{2}$ .  
The heterogeneous pair is pairwise stable if  $\underline{c} \leq \frac{1}{2}$ .*
- (ii) *The homogeneous line of length three is pairwise stable if  $\bar{c} = \frac{1}{6}$ .  
The heterogeneous line of length three such that two nodes of the same type are not consecutive is pairwise stable if  $\underline{c} \leq \frac{1}{6} \leq \bar{c}$ .*
- (iii) *A star with  $n$  leaves, all of the same type and different from the root,<sup>26</sup> is pairwise stable if  $\underline{c} \leq \frac{1}{n(n+1)}$  and  $\bar{c} \geq \frac{n-1}{2(n+1)}$ .*
- (iv) *Odd lines such that all nodes in odd positions are of one type and all nodes in even positions are of the other type are pairwise stable if  $\underline{c} \leq (m - \tilde{m})/2m\tilde{m} < 1/2m \leq \bar{c}$ .<sup>27</sup>*
- (v) *The odd cycles with at most  $\frac{1}{2\bar{c}}$  players, regardless of whether they are homogeneous or heterogeneous, are pairwise stable if  $\bar{c} \leq \frac{1}{6}$ .*
- (vi) *Star-like trees such that nodes of different types alternate and all the branches have the same, odd number of nodes are pairwise stable if  $\underline{c} \leq \frac{1}{-1+4|L|^2} < \frac{1}{2+4|L|} \leq \bar{c}$ .*
- (vii) *A succession of  $L \geq 2$  stars each with  $n \geq 2$  leaves, connected such that the hubs  $k$  and  $k + 1$  share a common leaf for  $k = \{1, \dots, L - 1\}$  and so that all the hubs are of the same type and different from the leaves is pairwise stable if  $\underline{c} \leq \frac{1}{(1+n(|L|-1))(1+n|L|)} < \frac{1-2|L|+n|L|}{2+2n|L|} \leq \bar{c}$ .*

<sup>26</sup>The heterogeneous line of length three such that two nodes of the same type are not consecutive is a particular case of this star.

<sup>27</sup>The heterogeneous line of length three such that two nodes of the same type are not consecutive is a particular case.

(viii) An expanded star in which every player  $\{1, \dots, L\}$  connected to the root by a link, all of them of the same type and different from the root itself, has the same number of exclusive neighbors  $n - 1$ , all of the same type as the root, is pairwise stable if  $\underline{c} \leq \frac{1}{(1+n(|L|-1))(1+n|L|)} < \frac{1-2|L|+n|L|}{2+2n|L|} \leq \bar{c}$ .

*Proof.*

In the Appendix. □

Figure 3 depicts some of the pairwise stable components derived in Lemma 3.

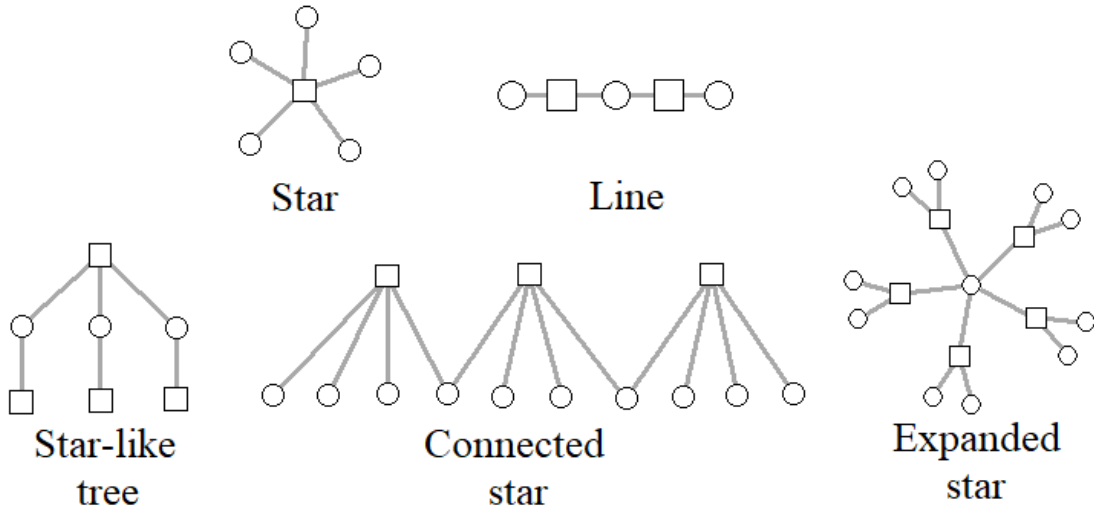

Figure 3: Some non-equitable pairwise stable components

*There are other bipartite graphs that are stable. Their complete characterization is still Work in Progress.*

## 4 Conclusions

This paper contributes to the literature of pairwise stable bargaining networks. We study a two-stage infinite-horizon bargaining game with two types of players and two states of the world, both of which are exogenously given. In the first stage, players form links whose overall cost depends on the players' types and the state of the world. In the second stage, players bargain *à la Manea* according to a uniform matching technology over the links they formed in the previous stage.

In our framework, components are homogeneous if they are composed only of players of the same type and are heterogeneous otherwise. Some of our equilibrium architectures are akin to those in Gauer and Hellmann (2017) in that we also obtain stable odd-cycles and pairs of players, both for homogeneous as well as for heterogeneous components. In this context, their work can be seen as a special case of ours since they only consider a single type of player and therefore a single cost.

Our main results are related to stable components with bipartite structures such as stars, odd lines and star-like trees. These architectures are feasible in contexts when complementarities among players of different types are sufficiently strong, with no two players of the same type having a link amongst them. Our results contrast with those of [Gauer and Hellmann \(2017\)](#) who obtain only one stable bipartite structure that consists of a line of three: in our setup, any odd-length line with interspersed heterogeneous players are pairwise stable. Furthermore, the line they get is only stable for one value of the cost, whereas our bipartite structures are stable for certain cost intervals.

Future research could focus along two lines that we find interesting. The first one consists in different kinds of projects coexisting, some requiring a single skill and others requiring both. In this case, it would be meaningful to model a search process in which players would try to find their best match. A second line is to extend our work to stationary and non-stationary bargaining with three or more types of players. In the stationary case, it is possible to consider a similar framework in which projects require either one or two skills but the complementarities depend on the distance between groups. For the non-stationary case, one could think of firms in different sectors interacting that could potentially collude and then withdraw from the collusion market.<sup>28</sup>

## A Appendix

In the proofs below we do heavy use of two lemmas in [Gauer and Hellmann \(2017\)](#):

**Lemma A.1** ([Gauer and Hellmann, 2017](#)). *If a network  $g$  is pairwise stable and the algorithm  $\mathcal{A}$  provides  $(r_1, x_1, M_1, L_1, N_1, g_1)$ , i.e.  $\bar{s} = 1$ , such that  $r_1 \in (0, 1)$ , then for all  $i, j \in M_1$  it is*

$$v_i^*(g + ij) = v_j^*(g + ij) = \frac{1}{2}.$$

*Further, if the player set  $N = \{1, \dots, n\}$  is extended by an isolated player  $n + 1$  such that the network  $g$  remains unchanged, it similarly is  $v_i^*(g + i(n + 1)) = v_{n+1}^*(g + i(n + 1)) = 1/2$ .*

**Lemma A.2** ([Gauer and Hellmann, 2017](#)). *If a network  $g$  is pairwise stable and the algorithm  $\mathcal{A}$  provides  $(r_1, x_1, M_1, L_1, N_1, g_1)$ , i.e.  $\bar{s} = 1$ , such that  $r_1 \in (0, 1)$ , then for all  $j \in L_1$ ,  $i \in M_1$  and  $kl \in g$  it is*

$$v_j^*(g - kl) \geq \frac{1}{2} \geq v_i^*(g - kl).$$

*Proof.* [Lemma 1](#)

- (i) Pairs: according to the definition of Pairwise Stability, we only need to find the condition for the existing link to be kept.

---

<sup>28</sup>This idea is inspired by [Elliott and Galeotti \(2019\)](#), who study the case of supermarkets with different stores weakly competing for consumers.

*Homogeneous*: the cost for each player to sustain the link is  $\underline{c}$ . When broken, they become isolated and get 0. Then,  $1/2 - \underline{c} \geq 0 \Leftrightarrow \underline{c} \leq 1/2$ . Therefore, the homogeneous pair is pairwise stable if  $\underline{c} \leq \frac{1}{2}$ .

*Heterogeneous*: the cost for each player to sustain the link is  $\bar{c}$ . When broken, they become isolated and get 0. Then,  $1/2 - \bar{c} \geq 0 \Leftrightarrow \bar{c} \leq 1/2$ . Therefore, the heterogeneous pair is pairwise stable if  $\bar{c} \leq \frac{1}{2}$ .

- (ii) Lines of length three: according to the definition of Pairwise Stability, we need to check that the two links connecting each peripheral player with the central node are kept, and that the peripheral players do not want to create a link among themselves.

*Homogeneous*: the cost for each player to sustain a link is  $\underline{c}$ . When broken, the central node becomes part of a pair, receiving the gross payoff  $1/2$ , and the peripheral node becomes isolated, getting 0. Then, for the link to be sustained:

- central node:  $\frac{2}{3} - \underline{c} \geq \frac{1}{2} \Leftrightarrow \underline{c} \leq \frac{1}{6}$ .
- peripheral node:  $\frac{1}{3} - \underline{c} \geq 0 \Leftrightarrow \underline{c} \leq \frac{1}{3}$ .

Thus, the link is sustained if  $\underline{c} \leq 1/6$ .

The cost for each peripheral player to form a new link is  $\underline{c}$ . Then, as the payoffs are the same for both peripheral nodes,

- create if  $\frac{1}{2} - \underline{c} > \frac{1}{3} \Leftrightarrow \underline{c} < \frac{1}{6}$ .

Thus, the link is not created if  $\underline{c} \geq 1/6$ .

Therefore, the homogeneous line of length three is pairwise stable if  $\underline{c} = \frac{1}{6}$ .

*Heterogeneous*: the cost for players of the same type to sustain a link is  $\underline{c}$ , while for players of different types it is  $\bar{c}$ . When broken, the central node becomes part of a pair, receiving the gross payoff  $1/2$ , and the peripheral node becomes isolated, getting 0. Then,

- central node with peripheral node of the same type:

- central node:  $\frac{2}{3} - \underline{c} \geq \frac{1}{2} \Leftrightarrow \underline{c} \leq \frac{1}{6}$ .
- peripheral node:  $\frac{1}{3} - \underline{c} \geq 0 \Leftrightarrow \underline{c} \leq \frac{1}{3}$ .

The link is sustained if  $\underline{c} \leq 1/6$ .

- central node with peripheral node of different type:

- central node:  $\frac{2}{3} - \bar{c} \geq \frac{1}{2} \Leftrightarrow \bar{c} \leq \frac{1}{6}$ .
- peripheral node:  $\frac{1}{3} - \bar{c} \geq 0 \Leftrightarrow \bar{c} \leq \frac{1}{3}$ .

The link is sustained if  $\bar{c} \leq 1/6$ .

The cost for each peripheral player to form a new link is  $\bar{c}$ , in which case an odd cycle is created and each player receives the gross payoff  $1/2$ . Then, as the payoffs are the same for both peripheral nodes,

· create if  $\frac{1}{2} - \bar{c} > \frac{1}{3} - \Leftrightarrow \bar{c} < \frac{1}{6}$ .

Thus, the link is not created if  $\bar{c} \geq 1/6$ .

Therefore, the heterogeneous line of length three such that two nodes of the same type are consecutive is pairwise stable if  $\bar{c} = \frac{1}{6}$ .

- (iii) Odd cycles: according to the definition of Pairwise Stability, we need to find the conditions for each node to keep the links with its two neighbors, and for no additional link to be created.

*Homogeneous:* the cost for each player to sustain a link is  $\underline{c}$ . If the link is broken, each node ends up at one of the extremes of an odd line of length  $\underline{m}$ , receiving the gross payoff  $(\underline{m} - 1)/2\underline{m}$ . Then,

$$\frac{1}{2} - \underline{c} \geq \frac{\underline{m} - 1}{2\underline{m}} \Leftrightarrow \underline{c} \leq \frac{1}{2\underline{m}}$$

As  $\underline{m} \geq 3$ ,  $\underline{c} \leq \frac{1}{6}$ .

Notice that, after creating a link between two nodes of the cycle that were unconnected, the gross payoff for each player remains  $\frac{1}{2}$ , as the cycle is odd. Then, these players were strictly better off without the additional link for any  $\underline{c} > 0$ .

Therefore, the homogeneous odd cycle with at most  $\frac{1}{2\underline{c}}$  players is pairwise stable if  $\underline{c} \leq \frac{1}{6}$ .

*Heterogeneous:* the cost for players of the same type to sustain a link is  $\underline{c}$ , while for players of different types it is  $\bar{c}$ . If the link is broken, each node ends up at one of the extremes of an odd line of length  $\bar{m}$ , receiving the gross payoff  $(\bar{m} - 1)/2\bar{m}$ . Sustaining links between players of different types automatically guarantees that links between players of the same type are sustained as well. Also, notice that in heterogeneous odd cycles there is always at least one link that costs  $\bar{c}$  for the players involved. Then,

$$\frac{1}{2} - \bar{c} \geq \frac{\bar{m} - 1}{2\bar{m}} \Leftrightarrow \bar{c} \leq \frac{1}{2\bar{m}}$$

As  $\bar{m} \geq 3$ ,  $\bar{c} \leq \frac{1}{6}$ .

Again, after creating a link between two nodes of the cycle that were unconnected, the gross payoff for each player remains  $\frac{1}{2}$ , as the cycle is odd. Then, these players were strictly better off without the additional link for any  $\underline{c} > 0$ .

Therefore, the heterogeneous cycle with at most  $\frac{1}{2\bar{c}}$  players is pairwise stable if  $\bar{c} \leq \frac{1}{6}$ .

Notice that the pairwise stability condition does not depend on the number of nodes of each type or on their positions within the heterogeneous cycle.

□

*Proof.* [Lemma 2](#)

- (i) Heterogeneous lines of length three such that two nodes of the same type are not consecutive.

In this structure, every existing link costs  $\bar{c}$  to each player. If any link is broken, the central player becomes part of a pair, receiving the gross payoff  $1/2$ , and the peripheral player becomes isolated, getting the payoff  $0$ . Then,

- central node:  $\frac{2}{3} - \bar{c} \geq \frac{1}{2} \Leftrightarrow \bar{c} \leq \frac{1}{6}$ .
- peripheral node:  $\frac{1}{3} - \bar{c} \geq 0 \Leftrightarrow \bar{c} \leq \frac{1}{3}$ .

The links are sustained if  $\bar{c} \leq 1/6$ .

The cost for each peripheral player to form a new link is  $\underline{c}$ , in which case an odd cycle is created and each player receives the gross payoff  $1/2$ . Then, as the payoffs are the same for both peripheral nodes,

- create if  $\frac{1}{2} - \underline{c} > \frac{1}{3} \Leftrightarrow \underline{c} < \frac{1}{6}$ .

The link is not created if  $\underline{c} \geq 1/6$ , but this condition contradicts  $\bar{c} \leq 1/6$ , and so the structure is not pairwise stable.

- (ii) Lines of length four or above.

We first focus on the even lines. In these structures, each node receives the gross payoff  $\frac{1}{2}$ . Consider the node connected to a peripheral player. It has to sustain two links in the even line, whereas if it kept the connection with the peripheral player only, it would still receive the gross payoff  $\frac{1}{2}$  while sustaining just one link, which makes it strictly better off for any positive value of the cost.

We now focus on the odd lines with five or more nodes,  $m$ . In these structures, the set  $M$  is composed of the odd nodes, so  $|M| = (m + 1)/2$ . Therefore,  $|L| = (m - 1)/2$  and  $r = |L|/|M| = (m - 1)/(m + 1) < 1$ . Accordingly, the gross payoff of the odd nodes is  $x_{odd} = r/(1 + r) = (m - 1)/2m$  and the gross payoff of the even nodes is  $x_{even} = 1/(1 + r) = (m + 1)/2m$ .

Consider the link between a peripheral player and the subsequent node. If it breaks, the peripheral node becomes isolated, so getting the payoff  $0$ , and the interior node becomes the extreme of an even line, so receiving the gross payoff  $\frac{1}{2}$ . The link with a peripheral player of the same type is sustained if  $(m + 1)/2m - \underline{c} \geq 1/2 \Leftrightarrow \underline{c} \leq 1/2m$  (and if  $\bar{c} \leq 1/2m$  when the peripheral player is of different type).

Consider now the link between two interior nodes. When it breaks, the node occupying the even position in the odd line becomes the extreme node of an even line, receiving the gross payoff  $1/2$ , whereas the node occupying the odd position in the odd line turns into the extreme node of a new odd line of length  $\tilde{m} < m$ , getting the gross payoff  $(\tilde{m} - 1)/2\tilde{m}$ . When the two interior

nodes are of the same type, the even node keeps the link if  $(m + 1)/2m - \underline{c} \geq 1/2 \Leftrightarrow \underline{c} \leq 1/2m$ , whereas the odd node keeps the link if  $(m - 1)/2m - \underline{c} \geq (\tilde{m} - 1)/2\tilde{m} \Leftrightarrow \underline{c} \leq (m - \tilde{m})/2m\tilde{m}$ . Thus, the link is sustained if  $\underline{c} \leq \min \left\{ \frac{1}{2m}, \frac{m-\tilde{m}}{2m\tilde{m}} \right\}$ . Analogously, when the two interior nodes are of different types, the link is sustained if  $\bar{c} \leq \min \left\{ \frac{1}{2m}, \frac{m-\tilde{m}}{2m\tilde{m}} \right\}$ .

Take an odd line such that the two peripheral nodes are of the same type. If the line connecting the two peripheral nodes were created, an odd cycle would result, implying that each node receives the gross payoff  $1/2$ . Thus, the link will not be created if  $\underline{c} \geq 1/2m$ . If the line is homogeneous, keeping all the links requires  $\underline{c} \leq (m - \tilde{m})/2m\tilde{m} < 1/2m$  (the last strict inequality coming from the fact that  $m \geq 5$ ), which contradicts  $\underline{c} \geq 1/2m$ . If the line is heterogeneous, keeping all the links requires  $\underline{c} < \bar{c} \leq \min \left\{ \frac{1}{2m}, \frac{m-\tilde{m}}{2m\tilde{m}} \right\}$ , which contradicts  $\underline{c} \geq 1/2m$ .

Take an odd line such that the two peripheral nodes are of different types. Notice that it is always possible to connect one of the peripheral nodes with an interior odd node of the same type. If such a link were created, the resulting structure would be an odd cycle connected to an even line and each player would get the gross payoff  $1/2$ . Thus, such a link will not be created if  $\underline{c} \geq 1/2m$ . As this line is by definition heterogeneous, keeping all links requires  $\underline{c} < \bar{c} \leq \min \left\{ \frac{1}{2m}, \frac{m-\tilde{m}}{2m\tilde{m}} \right\}$ , which contradicts  $\underline{c} \geq 1/2m$ .

(iii) Even cycles.

In these structures, each player receives the gross payoff  $1/2$ . However, if a link is broken, the resulting structure is an even line and, again, each player gets the gross payoff  $1/2$ . Therefore, the players that broke the link are strictly better off in the line, as they sustain a single link rather than two for any strictly positive value of the costs.

□

*Proof.* [Theorem 2](#)

Suppose that there are three or more nodes. In that case, there will always be at least two nodes of the same type. Then,  $\underline{c} \geq 1/2$  is sufficient to prevent the creation of any link: preventing the connection between two nodes of the same type also prevents the connection between two nodes of different types, as the former link is cheaper than the latter.

□

*Proof.* [Theorem 3](#)

Notice the following:

- (a) Two pairs never create a link to connect themselves. The reason is that the gross payoff of the nodes creating the link remains  $1/2$ , so the new structure makes them strictly worse off for any strictly positive value of the costs, as they have to sustain two links rather than one.



- (b) To prevent the formation of a link between an isolated node and the extreme of a pair that is of the same type,  $1/6 < \underline{c}$  is required (as for the node belonging to the pair is not profitable to become the central node of a line of length three if  $1/2 > 2/3 - \underline{c} \Leftrightarrow \underline{c} > 1/6$ ). Analogously, to prevent the formation of a link between an isolated and the extreme node of a pair that is of different type,  $1/6 < \bar{c}$  is required.

Consider a network with the characteristics specified in (i). The condition to sustain the homogeneous pairs is  $\underline{c} \leq 1/2$ , as it was stated in Lemma 1. To prevent the formation of a link between the isolated node and a pair that is of the same type,  $1/6 < \underline{c}$  is required. Since  $\bar{c} > \underline{c}$ , the previous condition also guarantees that a link between the isolated node and a pair that is of different type will not be formed. The intersection of all the conditions is  $\frac{1}{6} < \underline{c} \leq \frac{1}{2} \wedge \bar{c} > \underline{c}$ , which makes the network pairwise stable.

Consider a network with the characteristics specified in (ii). Again, the condition to sustain the homogeneous pairs is  $\underline{c} \leq 1/2$ . However, since there are no pairs of the same type as the isolated node, only  $1/6 < \bar{c}$  is required to prevent the formation of links. As by assumption  $\bar{c} > \underline{c}$ , the intersection of all the conditions is  $\underline{c} \leq \frac{1}{2} \wedge \bar{c} > \max\{\frac{1}{6}, \underline{c}\}$ , which makes the network pairwise stable.

Consider a network with the characteristics specified in the first part of statement (iii). Again, the condition to sustain the homogeneous pairs is  $\underline{c} \leq 1/2$ . As in (i),  $1/6 < \underline{c}$  is sufficient to prevent the formation of a link between an isolated node and a pair of the same type, and it also automatically prevents the creation of a link between an isolated node and a pair of different type. Finally, to prevent the formation of a link between the two isolated nodes that are of different types,  $1/2 \leq \bar{c}$  is required. The intersection of all conditions is  $\frac{1}{6} < \underline{c} \leq \frac{1}{2} \leq \bar{c} \wedge \bar{c} > \underline{c}$ , which makes the network pairwise stable.

Consider the particular case  $\frac{1}{6} < \underline{c} = \frac{1}{2} < \bar{c}$ .  $\underline{c} = 1/2$  is the intersection between  $\underline{c} \leq 1/2$ , sufficient to sustain homogeneous pairs, and  $\underline{c} \geq 1/2$ , sufficient to prevent the link between two isolated nodes of the same type. Plus, as  $\bar{c} > \underline{c}$ ,  $\bar{c} > \underline{c} \geq 1/2$  also prevents the link between two isolated nodes of different types (notice that, whenever there are three or more isolated nodes, there are at least two of them of the same type).

Finally, consider a network with characteristics specified in the first part of statement (iv). In this case, the condition to sustain the heterogeneous pair(s) is  $\bar{c} \leq 1/2$ , which also sustains the homogeneous pairs, if there is any. Notice that, as there is at least one heterogeneous pair, there is always a node of the same type as the isolated that belongs to a pair. The link between these two nodes is prevented if  $1/6 < \underline{c}$  (which is also sufficient to prevent the link between the isolated node and a node of different type that belongs to a pair). The intersection of all conditions is  $\frac{1}{6} < \underline{c} < \bar{c} \leq \frac{1}{2}$ , which makes the network pairwise stable.

Consider the particular case  $\frac{1}{6} < \underline{c} < \bar{c} = \frac{1}{2}$ .  $\bar{c} = 1/2$  is the intersection between  $\bar{c} \leq 1/2$ , sufficient to sustain heterogeneous pairs, and  $\bar{c} \geq 1/2$ , sufficient to prevent the link between two isolated nodes of different types, which allows to introduce one more isolated node different from the previous one. Notice that introducing one more isolated node of the same type is not pairwise stable: as  $\underline{c} \leq 1/2$ , a link

between them will be created. □

*Proof.* [Theorem 4](#)

Recall from the proof of Theorem 3 that two pairs do not create a link among themselves; that  $1/6 < \underline{c}$  is sufficient to prevent the formation of a link between an isolated node and the extreme of a pair that is of the same type; and that  $1/6 < \bar{c}$  is sufficient to prevent the formation of a link between an isolated node and the extreme of a pair that is of different type.

Also, notice that:

- (a) An odd cycle never creates a link with another structure, including an isolated node, because the player in the cycle creating such a link keeps receiving the gross payoff  $1/2$  while paying to sustain three links rather than two.
- (b) A link between a homogeneous line of length three and an isolated node of different type can be prevented if  $1/6 = \underline{c} < \bar{c}$ . If the line is either heterogeneous or homogeneous but of the same type as the isolated node, the creation of a link with the isolated player cannot be prevented. The reason is that the link between an isolated node and the extreme of a length-3 line that is of the same type is not created if  $\underline{c} > 1/6$ . In the former case, the homogeneous line is sustained if  $\underline{c} = 1/6$ , which contradicts  $\underline{c} > 1/6$ . In the latter case, the heterogeneous line is sustained if  $\bar{c} = 1/6$ , which again contradicts  $\underline{c} > 1/6$  because  $\bar{c} > \underline{c}$  by assumption.
- (c) A pair and a length-3 line such that they have extreme nodes of the same type do not create a link if  $\underline{c} > 1/15$ . Analogously, a pair and a length-3 line such that they do not have extreme nodes of the same type do not create a link if  $\bar{c} > 1/15$ . Also, notice that the central node of a line of length three does not create a link with a pair for any strictly positive level of the costs, as its gross payoff remains invariant after the creation of such a link.
- (d) Two homogeneous length-3 lines of the same type do not create a link if  $\underline{c} \geq 1/6$ ; analogously, two homogeneous length-3 lines of different types do not create a link if  $\bar{c} \geq 1/6$ . On the contrary, a link between a heterogeneous length-3 line and another length-3 line cannot be prevented. The reason is that a heterogeneous line always has one extreme that can connect with an extreme of the same type of another line (regardless of whether this line is homogeneous or heterogeneous). This link is not created if  $\underline{c} \geq 1/6$ , but the heterogeneous line is sustained if  $\bar{c} = 1/6$ , which contradicts the previous condition because  $\bar{c} > \underline{c}$  by assumption.

Consider a network with the characteristics specified in (i). Homogeneous odd cycles with at most  $1/2\underline{c}$  players are stable if  $\underline{c} \leq 1/6$ . When adding two isolated nodes, each of a different type, the whole network is pairwise stable by just preventing the link between them, as the cycles do not connect either with an isolated node or among themselves. Then, the network is pairwise stable if  $\underline{c} \leq \frac{1}{6} \wedge \bar{c} \geq \frac{1}{2}$ . Notice

that either pairs or lines of length three cannot fit in this network, as a link with the isolated node of the same type as the extreme node is not created if  $\underline{c} > 1/6$ , which makes the cycles unstable.

Consider a network with the characteristics specified in the first part of statement (ii). Homogeneous odd cycles with at most  $1/2\underline{c}$  players are stable if  $\underline{c} \leq 1/6$ . This condition automatically allows to add to the network either one isolated node or homogeneous pair(s): cycles do not create links with any other component, and  $\underline{c} \leq 1/6$  is stricter than  $\underline{c} \leq 1/2$ , which is the sufficient condition to sustain homogeneous pairs. Then, a network with these components is pairwise stable if  $\underline{c} \leq \frac{1}{6} \wedge \bar{c} > \underline{c}$ . Note that if there was at least one homogeneous pair of the same type as the isolated node, they would connect as  $\underline{c} \leq 1/6$ . See case (iv) for the pairwise stable conditions when all pairs are homogeneous and different from the isolated node. Consider the particular case  $\underline{c} = \frac{1}{6} < \bar{c}$ . If the network is only composed of homogeneous odd cycles and homogeneous pairs, then there can also be homogeneous lines of length three: cycles and pairs keep being stable, lines are sustained and they do not create links either between themselves ( $\underline{c} = 1/6 \geq 1/6$ ) or with pairs ( $1/15 < \underline{c} = 1/6 < \bar{c}$ ). However, if the network is composed of homogeneous odd cycles and one isolated node, homogeneous length-3 lines in general do not fit: as long as there is one line of the same type as the isolated player, a link between them cannot be prevented (as  $\underline{c} = 1/6$  contradicts  $\underline{c} > 1/6$ ). See case (iv) for the pairwise stability conditions when all lines are homogeneous and different from the isolated node.

Consider a network with the characteristics specified in the first part of statement (iii). Homogeneous odd cycles with at most  $1/2\underline{c}$  players are stable if  $\underline{c} \leq 1/6$ , and heterogeneous pairs are stable if  $\bar{c} \leq 1/2$  (which makes homogeneous pairs also sustainable, as  $\bar{c} > \underline{c}$ ). Then, the network is pairwise stable if  $\underline{c} \leq \frac{1}{6} \wedge \underline{c} < \bar{c} \leq \frac{1}{2}$ . Consider the particular case  $\frac{1}{6} = \underline{c} < \bar{c} \leq \frac{1}{2}$ . In this case, homogeneous lines of length three also fit in this network: cycles and pairs keep being stable, lines are sustained and they do not create links either between themselves ( $\underline{c} = 1/6 \geq 1/6$ ) or with pairs ( $1/15 < \underline{c} = 1/6$ ).

Consider a network with the characteristics specified in the first part of statement (iv). Homogeneous odd cycles with at most  $1/2\underline{c}$  players are stable if  $\underline{c} \leq 1/6$ , and so are homogeneous pairs as  $\underline{c} \leq 1/6$  is stricter than  $\underline{c} \leq 1/2$ . If  $\bar{c} > 1/6$ , given that all homogeneous pairs are of the same type, an isolated node of different type fits, since  $\bar{c} > 1/6$  prevents any link between these pairs and the isolated player. Then, the network is pairwise stable if  $\underline{c} \leq \frac{1}{6} < \bar{c}$ . Notice that if there was at least one heterogeneous pair or one homogeneous pair of the same type as the isolated node, the network would not be pairwise stable because the condition to prevent the link between one of these pairs and the isolated player is  $\underline{c} > 1/6$ , which contradicts the condition to sustain the cycles.

Consider the particular case  $\underline{c} = \frac{1}{6} < \bar{c}$ . If this is the case, homogeneous length-3 lines such that all are of the same type and different from the isolated node also fit: cycles and pairs keep being stable, lines are sustained, neither lines nor pairs create a link with the isolated player as  $\bar{c} > 1/6$ , lines do not create links between themselves because  $\underline{c} = 1/6 \geq 1/6$ , and lines and pairs do not connect because  $1/15 < \underline{c} = 1/6$ .

Consider a network with the characteristics specified in (v). Heterogeneous odd cycles with at most  $1/2\bar{c}$  players are stable if  $\bar{c} \leq 1/6$ , and so are homogeneous odd cycles with at most  $1/2\underline{c}$  players since  $\bar{c} > \underline{c}$ . This condition automatically allows to add to the network either one isolated node or pair(s), which can be homogeneous and/or heterogeneous: cycles do not create links with any other component and  $\bar{c} \leq 1/6$  is stricter than both  $\bar{c} \leq 1/2$  and  $\underline{c} \leq 1/2$ , which are the sufficient conditions to sustain heterogeneous and homogeneous pairs, respectively. Then, a network with these components is pairwise stable if  $\underline{c} < \bar{c} \leq \frac{1}{6}$ . Notice that, for these parametric conditions, a link between a pair and an isolated node cannot be prevented as  $\underline{c} < \bar{c} \leq 1/6$  contradicts both  $\bar{c} > 1/6$  and  $\underline{c} > 1/6$ , so these components cannot co-exist in this network.

Finally, consider a network with the characteristics specified in the first part of statement (vi). Heterogeneous odd cycles with 3 players are stable if  $\bar{c} = 1/6$ , which also sustains the heterogeneous line of length three. Since  $\bar{c} > \underline{c}$  by assumption, homogeneous cycles with at most  $1/2\underline{c}$  are also allowed, so the network is pairwise stable if  $\underline{c} < \bar{c} = \frac{1}{6}$ . Notice that more length-3 lines do not fit: as  $\underline{c} < 1/6$ , their extremes would always connect.

Consider the particular case  $\frac{1}{15} < \underline{c} < \bar{c} = \frac{1}{6}$ . Then, pairs homogeneous and/or heterogeneous also fit:  $\bar{c} = 1/6$  is stricter than both  $\bar{c} \leq 1/2$  and  $\underline{c} \leq 1/2$ , so allowing for pairs, and  $1/15 < \underline{c}$  prevents the creation of links between the heterogeneous line and a pair. However, since  $1/15 < \underline{c}$ , the number of players of the homogeneous odd cycle(s) can never be larger than seven.  $\square$

*Proof.* [Lemma 3](#)

- (i) Pairs: according to the definition of Pairwise Stability, we only need to find the condition for the existing link to be kept.

*Homogeneous:* the cost for each player to sustain the link is  $\bar{c}$ . When broken, they become isolated and get 0. Then,  $1/2 - \bar{c} \geq 0 \Leftrightarrow \bar{c} \leq 1/2$ . Therefore, the homogeneous pair is pairwise stable if  $\bar{c} \leq \frac{1}{2}$ .

*Heterogeneous:* the cost for each player to sustain the link is  $\underline{c}$ . When broken, they become isolated and get 0. Then,  $1/2 - \underline{c} \geq 0 \Leftrightarrow \underline{c} \leq 1/2$ . Therefore, the heterogeneous pair is pairwise stable if  $\underline{c} \leq \frac{1}{2}$ .

- (ii) Lines of length three: according to the definition of Pairwise Stability, we need to check that the two links connecting each peripheral player with the central node are kept, and that the peripheral players do not want to create a link among themselves.

*Homogeneous:* the cost for each player to sustain a link is  $\bar{c}$ . When broken, the central node becomes part of a pair, receiving the gross payoff  $1/2$ , and the peripheral node becomes isolated, getting 0. Then, for the link to be sustained:

- central node:  $\frac{2}{3} - \bar{c} \geq \frac{1}{2} \Leftrightarrow \bar{c} \leq \frac{1}{6}$ .
- peripheral node:  $\frac{1}{3} - \bar{c} \geq 0 \Leftrightarrow \bar{c} \leq \frac{1}{3}$ .

Thus, the link is sustained if  $\bar{c} \leq 1/6$ .

The cost for each peripheral player to form a new link is  $\bar{c}$ . Then, as the payoffs are the same for both peripheral nodes,

- create if  $\frac{1}{2} - \bar{c} > \frac{1}{3} \Leftrightarrow \bar{c} < \frac{1}{6}$ .

Thus, the link is not created if  $\bar{c} \geq 1/6$ .

Therefore, the homogeneous line of length three is pairwise stable if  $\bar{c} = \frac{1}{6}$ .

*Heterogeneous*: the cost for players of the different types to sustain a link is  $\underline{c}$ . When broken, the central node becomes part of a pair, receiving the gross payoff  $1/2$ , and the peripheral node becomes isolated, getting 0. Then, for the link to be sustained:

- central node:  $\frac{2}{3} - \underline{c} \geq \frac{1}{2} \Leftrightarrow \underline{c} \leq \frac{1}{6}$ .
- peripheral node:  $\frac{1}{3} - \underline{c} \geq 0 \Leftrightarrow \underline{c} \leq \frac{1}{3}$ .

Thus, the link is sustained if  $\underline{c} \leq 1/6$ .

The cost for each peripheral player to form a new link is  $\bar{c}$ , in which case an odd cycle is created and each player receives the gross payoff  $1/2$ . Then, as the payoffs are the same for both peripheral nodes,

- create if  $\frac{1}{2} - \bar{c} > \frac{1}{3} \Leftrightarrow \bar{c} < \frac{1}{6}$

Thus, the link is not created if  $\bar{c} \geq 1/6$ .

Therefore, the heterogeneous line of length three such that two nodes of the same type are not consecutive is pairwise stable if  $\underline{c} \leq \frac{1}{6} \leq \bar{c}$ .

(iii) Stars with  $n \geq 2$  leaves, all of the same type and different from the root.

To prove that the algorithm finishes in one step, we notice that there are only two options:  $\text{root} \in M$  and  $\text{root} \notin M$ . If  $\text{root} \in M$ , then  $|L| = n$  and so  $r = n > 1$ . If  $\text{root} \notin M$ , since the only neighbor of any leaf is the root, the shortage ratio decreases as the cardinality of  $M$  increases. Therefore,  $|M| = n$ ,  $|L| = 1$  and  $r = 1/n < 1$ .

Notice that all the links of this structure are cheap. When an existing link breaks, using an analogous argument, the algorithm finishes in one step for the non-singleton component with  $|M| = n - 1$  and  $|L| = 1$ . The leaf that becomes isolated gets payoff 0. Then, for the link to be sustained:

- root:  $\frac{n}{n+1} - \underline{c} \geq \frac{n-1}{n} \Leftrightarrow \underline{c} \leq \frac{1}{n(n+1)}$ .
- leaf:  $\frac{1}{n+1} - \underline{c} \geq 0 \Leftrightarrow \underline{c} \leq \frac{1}{n+1}$ .

Since all the links are qualitatively equal, all links are sustained if  $\underline{c} \leq \frac{1}{n(n+1)}$ .

Since there are links connecting each node in  $|M|$  with the single node in  $|L|$ , the only links that can be formed are among leaves. By [Lemma A.1](#), each leaf gets the gross payoff  $1/2$  and so the link is created if

$$\cdot \frac{1}{2} - \bar{c} > \frac{1}{n+1} \Leftrightarrow \bar{c} < \frac{n-1}{2(n+1)}.$$

Thus, the link is not created if  $\bar{c} \geq \frac{n-1}{2(n+1)}$ . Therefore, this structure is pairwise stable if  $\underline{c} \leq \frac{1}{n(n+1)} \leq \frac{n-1}{2(n+1)} \leq \bar{c}$ .

- (iv) Odd lines such that nodes of different types alternate: given the alternating types of the nodes, all the existing links are cheap. Furthermore, the creation of odd cycles implies establishing an expensive link, which has to be deterred for the structure to be pairwise stable.<sup>29</sup>

Let us focus on the odd lines with five or more nodes,  $m \geq 5$ , as the line of three nodes has been discussed previously. In these structures, the set  $M$  is composed of the odd nodes, so  $|M| = (m+1)/2$ . Therefore,  $|L| = (m-1)/2$  and  $r = |L|/|M| = (m-1)/(m+1) < 1$ . Accordingly, the gross payoff of the odd nodes is  $x_{odd} = r/(1+r) = (m-1)/2m$  and the gross payoff of the even nodes is  $x_{even} = 1/(1+r) = (m+1)/2m$ .

Consider the link between a peripheral player and the subsequent node. If it breaks, the peripheral node becomes isolated, so getting the payoff 0, and the interior node becomes the extreme of an even line, so receiving the gross payoff  $\frac{1}{2}$ . The link is sustained if  $(m+1)/2m - \underline{c} \geq 1/2 \Leftrightarrow \underline{c} \leq 1/2m$ .

Consider now the link between two interior nodes. When it breaks, the node occupying the even position in the odd line becomes the extreme node of an even line, receiving the gross payoff  $1/2$ , whereas the node occupying the odd position in the odd line turns into the extreme node of a new odd line of length  $\tilde{m} < m$ , getting the gross payoff  $(\tilde{m}-1)/2\tilde{m}$ . The even node keeps the link if  $(m+1)/2m - \underline{c} \geq 1/2 \Leftrightarrow \underline{c} \leq 1/2m$ , whereas the odd node keeps the link if  $(m-1)/2m - \underline{c} \geq (\tilde{m}-1)/2\tilde{m} \Leftrightarrow \underline{c} \leq (m-\tilde{m})/2m\tilde{m}$ . Thus, the link is sustained if  $\underline{c} \leq \min \left\{ \frac{1}{2m}, \frac{m-\tilde{m}}{2m\tilde{m}} \right\}$ .

Notice that, as  $m \geq 5$ , to keep all the links requires  $\underline{c} \leq (m-\tilde{m})/2m\tilde{m} < 1/2m$ .

Regarding the creation of a new link such that an odd cycle results, notice that only the nodes in odd positions could be benefited by it. For the nodes in even positions, the gross payoff would not change after the creation of the link, so they would be strictly worse off.

When two nodes occupying odd positions create a link, each one of them gets the gross payoff  $1/2$ , but such a link is expensive. Then,

$$\cdot \text{ create if } \frac{1}{2} - \bar{c} > \frac{m-1}{2m} \Leftrightarrow \bar{c} < \frac{1}{2m}$$

Thus, the link is not created if  $\bar{c} \geq 1/2m$ , and the entire structure is pairwise stable if  $\underline{c} \leq (m-\tilde{m})/2m\tilde{m} < 1/2m \leq \bar{c}$ .

- (v) Odd cycles: according to the definition of Pairwise Stability, we need to find the conditions for each node to keep the links with its two neighbors, and for no additional link to be created.

---

<sup>29</sup>Even cycles are never created.

Since the cycles are odd, regardless of whether they are homogeneous or heterogeneous, there will be two consecutive nodes of the same type; that is, there exists at least one expensive link that, if sustained, implies the sustainability of the cheap links as well.

If such a link is broken, each node ends up at one of the extremes of an odd line of length  $\bar{m}$ , receiving the gross payoff  $(\bar{m} - 1)/2\bar{m}$ . Then,

$$\frac{1}{2} - \bar{c} \geq \frac{\bar{m} - 1}{2\bar{m}} \Leftrightarrow \bar{c} \leq \frac{1}{2\bar{m}}.$$

As  $\bar{m} \geq 3$ ,  $\bar{c} \leq \frac{1}{6}$ .

After creating a link between two nodes of the cycle that were unconnected, the gross payoff for each player remains  $\frac{1}{2}$ , as the cycle is odd. Then, these players were strictly better off without the additional link for any  $\underline{c} > 0$ .

Therefore, an odd cycle with at most  $\frac{1}{2\bar{c}}$  players is pairwise stable if  $\bar{c} \leq \frac{1}{6}$ .

- (vi) Star-like trees such that nodes of different types alternate and all the branches have the same, odd number of nodes:

Let  $n \geq 2$  be the number of branches and  $p \geq 1$  be the number of nodes of different type from the root in each branch. Then, the set  $|L| = np \geq 2$  is composed of all the nodes of different type from the root and the set  $|M| = |L| + 1$  is composed of all the nodes of the same type as the root. Then, the payoff for each agent in  $|M|$  is  $x_M = |L|/(2|L| + 1)$  and the payoff for each agent in  $|L|$  is  $x_L = (|L| + 1)/(2|L| + 1)$ .

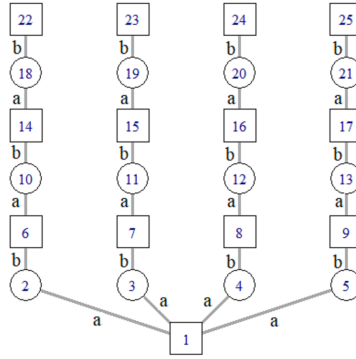

Figure 4: Star-like tree.

As it can be seen in Figure 4, there are two types of links: (a) and (b). If a link of type (a) breaks, the two resulting components are (i) an even line, and (ii) a star-like tree with  $n - 1$  branches of the original length and one branch with  $k \in [0, p - 1]$  nodes of type different from the root, each matched by a subsequent node of the same type as the root. If a link of type (b) breaks, the



two resulting components are (i) an odd line of length  $2(p - k) + 1$ , and (ii) a star-like tree with  $n - 1$  branches of the original length and one branch with  $k \in [1, p]$  nodes of type different from the root such that only the last one is not matched by a subsequent node of the same type as the root.

If a link of type (a) breaks, the shortage ratio of the first component is  $\tilde{r}_{(1)} = 1$ , and so the payoff for the node that is now in the line is  $\tilde{x}_L = 1/2$ . The shortage ratio of the second component is  $\tilde{r}_{(2)} = ((n - 1)p + k)/((n - 1)p + k + 1)$  and so the payoff for the node that remains in the star-like tree component becomes  $\tilde{x}_M = ((n - 1)p + k)/(2(n - 1)p + 2k + 1)$ . Then:

- node in the line:  $\frac{np+1}{2np+1} - \underline{c} \geq \frac{1}{2} \Leftrightarrow \underline{c} \leq \frac{1}{2+4np}$
- node in the star-like tree:  
 $\frac{np}{2np+1} - \underline{c} \geq \frac{(n-1)p+k}{2(n-1)p+2k+1} \Leftrightarrow \underline{c} \leq \frac{p-k}{(2(n-1)p+2k+1)(2np+1)} = \mathcal{K}$ .

Notice that  $\mathcal{K}$  is a function of  $k$ . Then, we need to find the strictest condition on the costs: the value of  $k$  that minimizes  $\mathcal{K}$ . Since  $\partial\mathcal{K}/\partial k < 0$ ,  $\mathcal{K}$  achieves its minimum at  $k = p - 1$ , and so all links of type (a) are sustained if  $\underline{c} \leq \frac{1}{-1+4n^2p^2} = \frac{1}{-1+4|L|^2}$ .<sup>30</sup>

If a link of type (b) breaks, the shortage ratio of the first component is  $\tilde{r}_{(1)} = 2(p - k)/(2(p - k) + 2)$ , and so the payoff for the node that is now in the line is  $\tilde{x}_M = 2(p - k)/(4(p - k) + 2)$ . The shortage ratio of the second component is  $\tilde{r}_{(2)} = 1$  and so the payoff for the node that remains in the star-like tree component becomes  $\tilde{x}_L = 1/2$ . Then:

- node in the line:  $\frac{np}{2np+1} - \underline{c} \geq \frac{2(p-k)}{4(p-k)+2} \Leftrightarrow \underline{c} \leq \frac{(n-1)p+k}{(2(p-k)+1)(1+2n)} = \hat{\mathcal{K}}$
- node in the star-like tree:  
 $\frac{np+1}{2np+1} - \underline{c} \geq \frac{1}{2} \Leftrightarrow \underline{c} \leq \frac{1}{2+4np}$ .

Notice that  $\hat{\mathcal{K}}$  is a function of  $k$ . Then, we need to find the strictest condition on the costs: the value of  $k$  that minimizes  $\mathcal{K}$ . Since  $\partial\mathcal{K}/\partial k > 0$ ,  $\mathcal{K}$  achieves its minimum at  $k = 1$ , and so all links of type (b) are sustained if  $\underline{c} \leq \frac{1}{2+4np} = \frac{1}{2+4|L|}$ .<sup>31</sup>

Therefore, no link breaks if  $\underline{c} \leq \frac{1}{-1+4|L|^2}$ .

Now we need to check that no link is formed. There are 8 possible types of links that can be formed: (1) between two nodes of different type from the root that are in different branches (for example, nodes 19 and 20); (2) between two nodes of different type from the root that are in the same branch (for example, nodes 2 and 10); (3) between two nodes of different types that are in different branches (for example, nodes 2 and 7); (4) between two nodes of different types that are in the same branch (for example, nodes 6 and 18); (5) between the root and a node of different type (for example, nodes 1 and

<sup>30</sup>  $\frac{1}{2+4np} > \frac{1}{-1+4n^2p^2}$ .

<sup>31</sup>  $\frac{(n-1)p+1}{(2(p-1)+1)(1+2n)} > \frac{1}{2+4np}$ .

10); (6) between two nodes of the same type as the root that are in different branches (for example, nodes 6 and 15); (7) between two nodes of the same type as the root that are in the same branch (for example, nodes 6 and 14); and (8) between the root and a node of the same type (for example, nodes 1 and 9).

Links (1)-(5) will not be formed: the payoff of the nodes belonging to set  $|L|$  (that is, all nodes of type different from the root) cannot increase but creating the link is costly. If any of the other three types formed, the algorithm would finish in two steps and it would give a payoff of  $1/2$  for each of the nodes that created the new link. Since in all cases the connecting players belong to the set  $|M|$ :

$$\cdot \text{ create if } \frac{1}{2} - \bar{c} > \frac{np}{2np+1} \Leftrightarrow \bar{c} < \frac{1}{2+4np} = \frac{1}{2+4|L|}.$$

Thus, the link is not created if  $\bar{c} \geq \frac{1}{2+4|L|}$ .

Therefore, the entire structure is pairwise stable if  $\underline{c} \leq \frac{1}{-1+4|L|^2} < \frac{1}{2+4|L|} \leq \bar{c}$ .

- (vii) Succession of  $L \geq 2$  stars each with  $n \geq 2$  leaves, connected such that the hubs  $k$  and  $k + 1$  share a common leaf for  $k = \{1, \dots, L - 1\}$  and so that all the hubs are of the same type and different from the leaves:

We need to prove first two intermediate results:

**Result 1:** A structure of two stars connected through one leaf cannot be stable if each star has a different number of leaves.

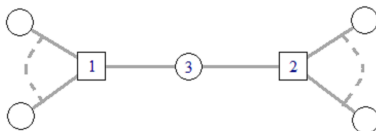

Figure 5: Non-symmetric, connected stars.

Without loss of generality, assume that the leaves (including the common leaf 3) of the stars with centers identified by 1 and 2 in Figure 5 are such that  $n_1 \geq n_2 + 1$ . In the first step, the algorithm minimizes the shortage ratio by taking  $|M_1| = n_1 - 1$  (that is, the leaves of star 1 excluding the common leaf 3) and  $|L_1| = 1$ . This implies that the link between the center 1 and the leaf 3 is a disagreement link, so both players are strictly better off by cutting it.

**Result 2:** A structure formed by a succession of  $L \geq 2$  stars each with  $n \geq L + 1$  leaves cannot be stable if the stars are connected through two or more leaves.<sup>32</sup>

<sup>32</sup>If  $L = 2$  and  $n = 2$ , we have a cycle of 4. In that case, the minimum shortage ratio is 1 and any pair of players is better off by cutting the link.

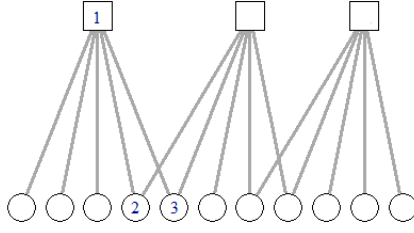

Figure 6: Stars connected through more than one leaf.

Let  $L \geq 2$  and  $n \geq L + 1$ . In that case, the sets that minimize the shortage ratio are  $|L| = L$  (that is, the centers of the stars) and  $|M| = n|L| - (2|L| - 1) = (n - 2)|L| + 1$  (that is, all the leaves). Consider that the link between 1 and 3 in Figure 6 breaks. The sets  $|L|$  and  $|M|$  are the same, so the payoffs remain the same and players 1 and 3 are strictly better off by cutting the link.

We are now ready to derive the conditions for pairwise stability of the structure consisting of a succession of  $L \geq 2$  stars each with  $n \geq 2$  leaves, connected such that the hubs  $k$  and  $k + 1$  share a common leaf for  $k = \{1, \dots, L - 1\}$  and so that all the hubs are of the same type and different from the leaves.

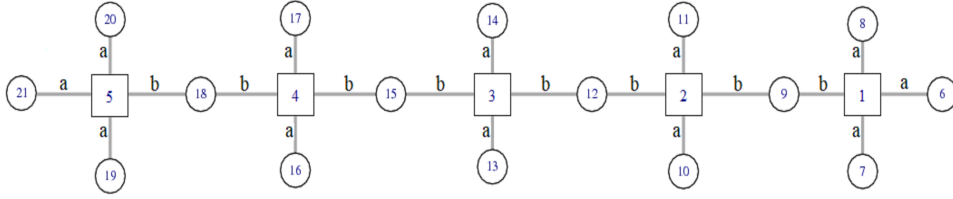

Figure 7: Connected stars.

For this structure, the sets  $|L|$  and  $|M|$  that minimize the shortage ratio are  $|L| = L$  (that is, the set of hubs) and  $|M| = n|L| - (|L| - 1) = (n - 1)|L| + 1$  (that is, the set of leaves). Then, the payoff for each agent in  $|M|$  is  $x_M = |L| / (n|L| + 1)$  and the payoff for each agent in  $|L|$  is  $x_L = ((n - 1)|L| + 1) / ((n|L| + 1))$ .

As it can be seen in Figure 7, there are two types of links: (a) and (b). If a link of type (a) breaks, the two resulting components are (i) an isolated node, and (ii) a component such that one of the stars has  $n - 1$  leaves and the others have  $n$  leaves. If a link of type (b) breaks, the two resulting components are (i) a component with  $J \geq 1$  stars such that one of the stars has  $n - 1$  leaves and the others have  $n$  leaves, and (ii) a component with  $(L - J)$  stars such that all have  $n$  leaves.

If a link of type (a) breaks, the shortage ratio becomes  $\tilde{r} = 1 / (n - 1)$  and the gross payoff for the isolated node is 0 whereas the gross payoff for the node in  $|L|$  becomes  $\tilde{x}_L = (n - 1) / n$ . Then:

- isolated node:  $\frac{|L|}{n|L|+1} - \underline{c} \geq 0 \Leftrightarrow \underline{c} \leq \frac{|L|}{n|L|+1}$
- node in  $|L|$ :  $\frac{(n-1)|L|+1}{n|L|+1} - \underline{c} \geq \frac{n-1}{n} \Leftrightarrow \underline{c} \leq \frac{1}{n+|L|n^2}$ .

A link of type (a) is sustained if  $\underline{c} \leq \frac{1}{n+|L|n^2}$ .

If a link of type (b) breaks, the shortage ratio of the first component is  $\tilde{r}_{(1)} = 1/(n-1)$ , and so the payoff for the hub after the link breaks is  $\tilde{x}_L = (n-1)/n$ . The shortage ratio of the second component is  $\tilde{r}_{(2)} = (L-J)/(n(L-J) - (L-J-1))$  and so the payoff of the leaf after the link breaks is  $\tilde{x}_M = (L-J)/(n(L-J)+1)$ . Then:

- hub:  $\frac{(n-1)|L|+1}{n|L|+1} - \underline{c} \geq \frac{n-1}{n} \Leftrightarrow \underline{c} \leq \frac{1}{n+|L|n^2}$
- leaf:  $\frac{|L|}{n|L|+1} - \underline{c} \geq \frac{|L|-J}{n(|L|-J)+1} \Leftrightarrow \underline{c} \leq \frac{J}{(1+n(|L|-J))(1+n|L|)} = \mathcal{J}$ .

Notice that  $\mathcal{J}$  is a function of  $J$ . Then, we need to find the strictest condition on the costs: the value of  $J$  that minimizes  $\mathcal{J}$ . Since  $\partial\mathcal{J}/\partial J > 0$ ,  $\mathcal{J}$  achieves its minimum at  $J = 1$ , and so all links of type (b) are sustained if  $\underline{c} \leq \frac{1}{(1+n(|L|-1))(1+n|L|)}$ .

No link breaks if  $\underline{c} \leq \frac{1}{(1+n(|L|-1))(1+n|L|)}$ .

Now we need to check that no link is formed. There are 7 possible types of links that can be formed: (1) between two leaves exclusive of the same hub (for instance, nodes 6 and 7); (2) between an exclusive leaf and a connecting leaf that are neighbors of the same hub (for instance, nodes 8 and 9); (3) between two exclusive leaves of different hubs (for instance, nodes 7 and 10); (4) between an exclusive leaf of one hub and a connecting leaf of another hub (for instance, nodes 11 and 15); (5) between two connecting leaves (for instance, nodes 9 and 12); (6) between two hubs (for instance, nodes 1 and 2); and (7) between a hub and an exclusive leaf of some another hub (for instance, nodes 5 and 17).

Links (6) and (7) will not be formed: the payoff of the hubs, since they are in set  $|L|$ , will not increase while it is costly to create the link. If any of the other five types formed, the algorithm would finish in three steps and it would give a payoff of  $1/2$  for each of the nodes that created the new link. Since in all cases the connecting players belong to the set  $|M|$ :

- create if  $\frac{1}{2} - \bar{c} > \frac{|L|}{n|L|+1} \Leftrightarrow \bar{c} < \frac{1-2|L|+n|L|}{2+2n|L|}$

Thus, the link is not created if  $\bar{c} \geq \frac{1-2|L|+n|L|}{2+2n|L|}$ .

Therefore, the entire structure is pairwise stable if  $\underline{c} \leq \frac{1}{(1+n(|L|-1))(1+n|L|)} < \frac{1-2|L|+n|L|}{2+2n|L|} \leq \bar{c}$ .

- (viii) Expanded star in which every player  $\{1, \dots, L\}$  connected to the root by a link, all of them of the same type and different from the root itself, has the same number of exclusive neighbors  $n-1$ , all of the same type as the root:

The set  $|L| \geq 2$  is composed of the nodes directly connected to the root, and the set  $|M| = (n-1)|L| + 1$  is composed of the exclusive neighbors of the nodes in  $|L|$  and the root. Then, the algorithm finishes in one step, the minimum shortage ratio is  $r = |L|/((n-1)|L| + 1)$  and the equilibrium payoffs are  $x_M = |L|/(n|L| + 1)$  and  $x_L = ((n-1)|L| + 1)/(n|L| + 1)$ .

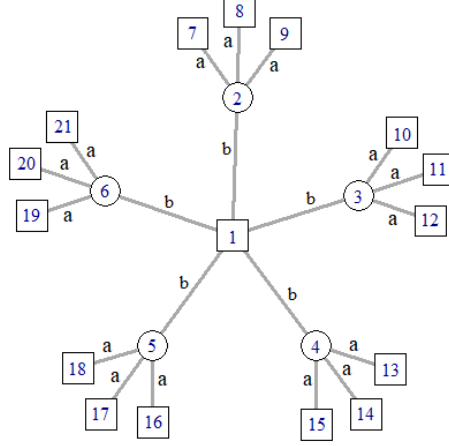

Figure 8: Expanded star.

As it is shown in Figure 8, there are two types of links. If a link of type (a) breaks, the two resulting components are (i) an isolated node, and (ii) a component such that  $|L| - 1$  of the nodes originally in set  $|L|$  keep their  $n - 1$  exclusive neighbors and the remaining node now has  $n - 2$  exclusive neighbors. If a link of type (b) breaks, the two resulting components are (i) a star with  $n - 1$  leaves, and (ii) a component identical to the original one but with  $|L| - 1$  players directly connected to the root instead.

If a link of type (a) breaks, the shortage ratio becomes  $\tilde{r} = 1/(n - 1)$  and the gross payoff for the isolated node is 0 whereas the gross payoff for the node in  $|L|$  becomes  $\tilde{x}_L = (n - 1)/n$ . Then:

- isolated node:  $\frac{|L|}{n|L|+1} - \underline{c} \geq 0 \Leftrightarrow \underline{c} \leq \frac{|L|}{n|L|+1}$
- node in  $|L|$ :  $\frac{(n-1)|L|+1}{n|L|+1} - \underline{c} \geq \frac{n-1}{n} \Leftrightarrow \underline{c} \leq \frac{1}{n+|L|n^2}$ .

A link of type (a) is sustained if  $\underline{c} \leq \frac{1}{n+|L|n^2}$ .

If a link of type (b) breaks, the shortage ratio for the first component becomes  $\tilde{r}(i) = 1/(n - 1)$ , the shortage ratio for the second component becomes  $\tilde{r}(ii) = (|L| - 1)/((n - 1)(|L| - 1) + 1)$ , and so the gross payoff for the root of the small star is  $(n - 1)/n$  whereas the gross payoff for the original root becomes  $\tilde{x}_L = (|L| - 1)/(n(|L| - 1) + 1)$ . Then:

- root of the small star:  $\frac{(n-1)|L|+1}{n|L|+1} - \underline{c} \geq \frac{n-1}{n} \Leftrightarrow \underline{c} \leq \frac{1}{n+|L|n^2}$

$$\cdot \text{ original root: } \frac{|L|}{n|L|+1} - \underline{c} \geq \frac{|L|-1}{n(|L|-1)+1} \Leftrightarrow \underline{c} \leq \frac{1}{(1+n(|L|-1))(1+n|L|)}.$$

A link of type (b) is sustained if  $\underline{c} \leq \frac{1}{(1+n(|L|-1))(1+n|L|)}$ .

No link breaks if  $\underline{c} \leq \frac{1}{(1+n(|L|-1))(1+n|L|)}$ .

Now we need to check that no link is formed. There are 5 possible types of links that can be formed: (1) between nodes directly connected to the root (for instance, nodes 2 and 3); (2) between a node directly connected with the root and an exclusive neighbor of some another player (for instance, nodes 2 and 21); (3) between two exclusive neighbors of the same player (for instance, nodes 8 and 9); (4) between two exclusive neighbors of different players (for instance, nodes 7 and 21); and (5) between the root and one exclusive neighbor (for instance, nodes 1 and 9).

Links (1) and (2) will not be formed: the payoff of the player(s) in set  $|L|$  will not increase while it is costly to create the link. If any of the other three types formed, the algorithm would finish in three steps and it would give a payoff of  $1/2$  for each of the nodes that created the new link. Since in all cases the connecting players belong to the set  $|M|$ :

$$\cdot \text{ create if } \frac{1}{2} - \bar{c} > \frac{|L|}{n|L|+1} \Leftrightarrow \bar{c} < \frac{1-2|L|+n|L|}{2+2n|L|}$$

Thus, the link is not created if  $\bar{c} \geq \frac{1-2|L|+n|L|}{2+2n|L|}$ .

Therefore, the entire structure is pairwise stable if  $\underline{c} \leq \frac{1}{(1+n(|L|-1))(1+n|L|)} < \frac{1-2|L|+n|L|}{2+2n|L|} \leq \bar{c}$ .

□

## References

- Abreu, D. and Manea, M. (2012a). Bargaining and efficiency in networks. *Journal of Economic Theory*, 147(1):43–70.
- Abreu, D. and Manea, M. (2012b). Markov equilibria in a model of bargaining in networks. *Games and Economic Behavior*, 75(1):1–16.
- Bala, V. and Goyal, S. (2000). A noncooperative model of network formation. *Econometrica*, 68(5):1181–1229.
- Bloch, F., Dutta, B., and Manea, M. (2019). Efficient partnership formation in networks. *Theoretical Economics*, 14(3):779–811.
- Corominas-Bosch, M. (2004). Bargaining in a network of buyers and sellers. *Journal of Economic Theory*, 115(1):35–77.
- Dawid, H. and Hellmann, T. (2014). The evolution of r&d networks. *Journal of Economic Behavior & Organization*, 105:158–172.

- Elliott, M. and Galeotti, A. (2019). The role of networks in antitrust investigations. *Oxford Review of Economic Policy*, 35(4):614–637.
- Elliott, M. and Nava, F. (2019). Decentralized bargaining in matching markets: Efficient stationary equilibria and the core. *Theoretical Economics*, 14(1):211–251.
- Galeotti, A. and Goyal, S. (2010). The law of the few. *American Economic Review*, 100(4):1468–92.
- Galeotti, A., Goyal, S., and Kamphorst, J. (2006). Network formation with heterogeneous players. *Games and Economic Behavior*, 54(2):353–372.
- Gauer, F. and Hellmann, T. (2017). Strategic formation of homogeneous bargaining networks. *Games and Economic Behavior*, 106:51–74.
- Goyal, S. and Joshi, S. (2003). Networks of collaboration in oligopoly. *Games and Economic behavior*, 43(1):57–85.
- Goyal, S. and Moraga-Gonzalez, J. L. (2001). R&d networks. *Rand Journal of Economics*, pages 686–707.
- Jackson, M. O. and Wolinsky, A. (1996). A strategic model of social and economic networks. *Journal of economic theory*, 71(1):44–74.
- Kranton, R. E. and Minehart, D. F. (2001). A theory of buyer-seller networks. *American economic review*, 91(3):485–508.
- Manea, M. (2011). Bargaining in stationary networks. *American Economic Review*, 101(5):2042–80.
- Nash, J. F. (1950). The bargaining problem. *Econometrica: Journal of the Econometric Society*, pages 155–162.
- Nash, J. F. (1953). Two-person cooperative games. *Econometrica: Journal of the Econometric Society*, pages 128–140.
- Newman, M. E. (2004). Coauthorship networks and patterns of scientific collaboration. *Proceedings of the national academy of sciences*, 101(suppl 1):5200–5205.
- Polanski, A. (2007). Bilateral bargaining in networks. *Journal of Economic Theory*, 134(1):557–565.
- Rubinstein, A. (1982). Perfect equilibrium in a bargaining model. *Econometrica: Journal of the Econometric Society*, pages 97–109.
- Rubinstein, A. and Wolinsky, A. (1985). Equilibrium in a market with sequential bargaining. *Econometrica: Journal of the Econometric Society*, pages 1133–1150.